

**FEZER**

VAKUUM · TRANSPORT · TECHNIK  
AUTOMATISIERUNGSTECHNIK

# VACUPOWERLIFT

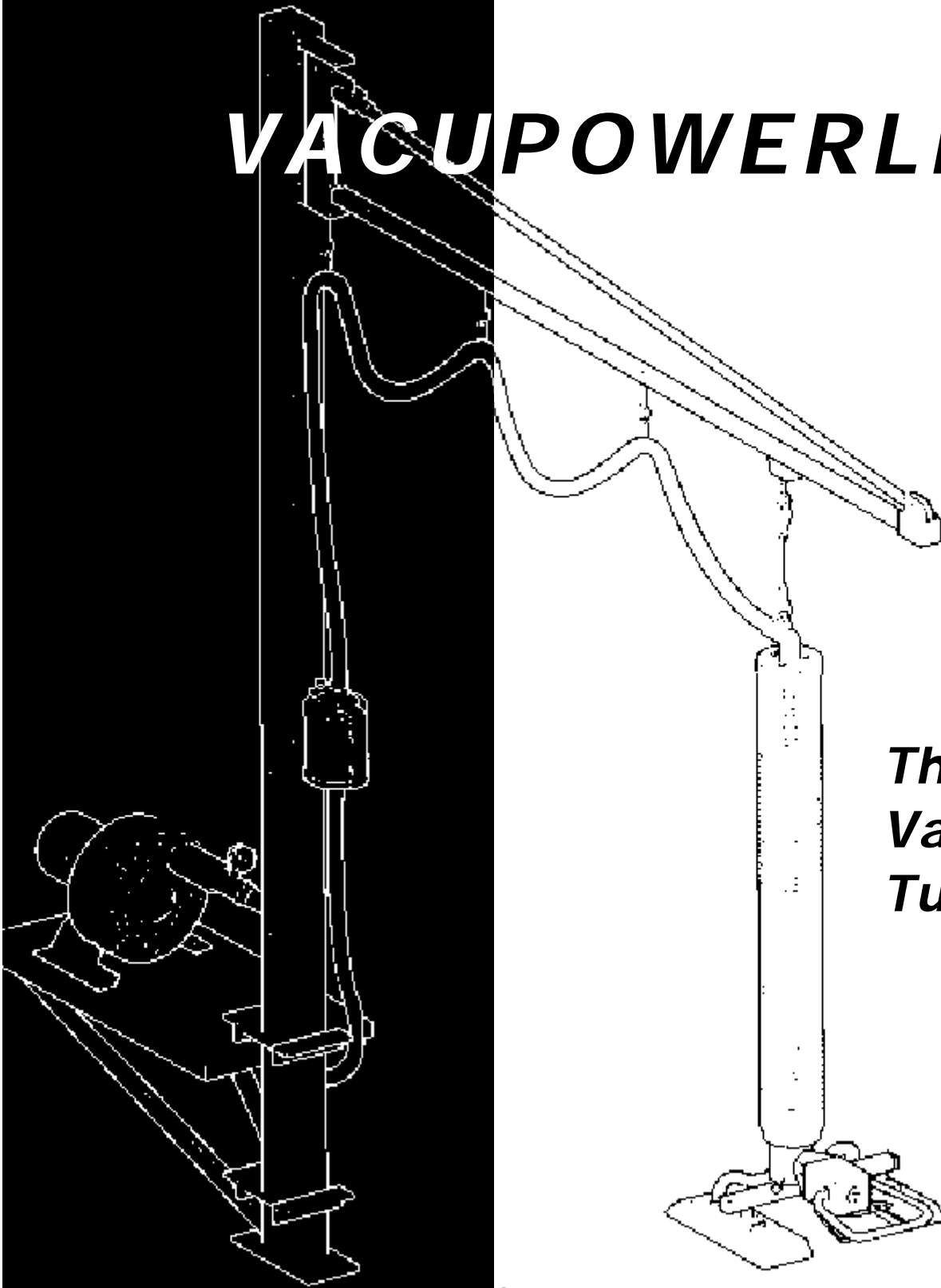

*The  
Vacuum  
Tube Lifter*

*Technical Catalogue  
Price List 01/2001*

The VacuPowerlift is available in 7 weight categories from 30 kgs to 120 kgs. It is a modular system which can be mounted by two basic systems.

In the following catalogue you will find the individual weight categories a survey of all components.

VacuPowerlift VPL 100	Page 3 / 4
VacuPowerlift VPL 120	Page 5 / 6
VacuPowerlift VPL 140	Page 7 / 8
VacuPowerlift VPL 160	Page 9 / 10
VacuPowerlift VPL 180	Page 11/12
VacuPowerlift VPL 200	Page 13/14
VacuPowerlift VPL 230	Page 15/16
<b>Blower:</b>	Page 17/18
<b>Accessories:</b>	Page 18/20
<b>Wall mounted slewing jib:</b>	Page 21
<b>column slewing jib:</b>	Page 22
<b>Accessories:</b>	Page 25

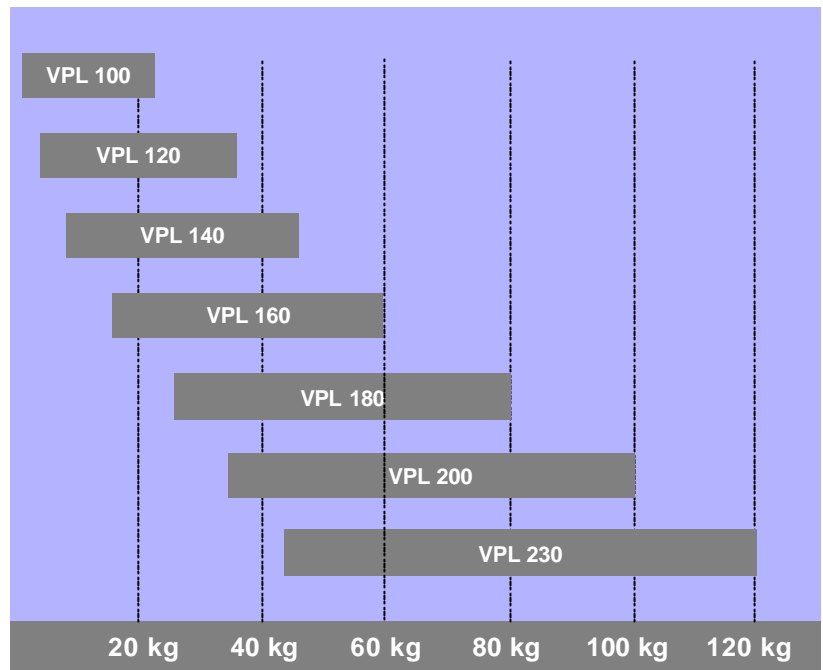

The VacuPowerlift is basically composed of the following 6 elements:

- 1 Vacuum Blower**
- 2 Lifting Unit with Control Housing**
  - Swivelling Head
  - Lifting Tube
  - Suction Head
  - Control Housing
- 3 Control Housing**
  - with moving gripp or turnable gripp
- 4 Suction Feet**
  - Single Suction Feet
  - Double Suction Feet
  - Fourfold Suction Feet
- 5 Accessories**
  - Blower Hoses and Filters
  - Adapters
- 6 Crane Units**
  - Wall mounted slewing jib
  - column slewing jib:
  - Railway Systems

The principle of the vacuum tube lifter is based on the use of the same vacuum for suction and holding of loads. The essential thing is the relation between the areas of the tube lifter and the suction feet. This relation must be:

Area Suction Feet	> =	2,5
Area Tube Lifter		

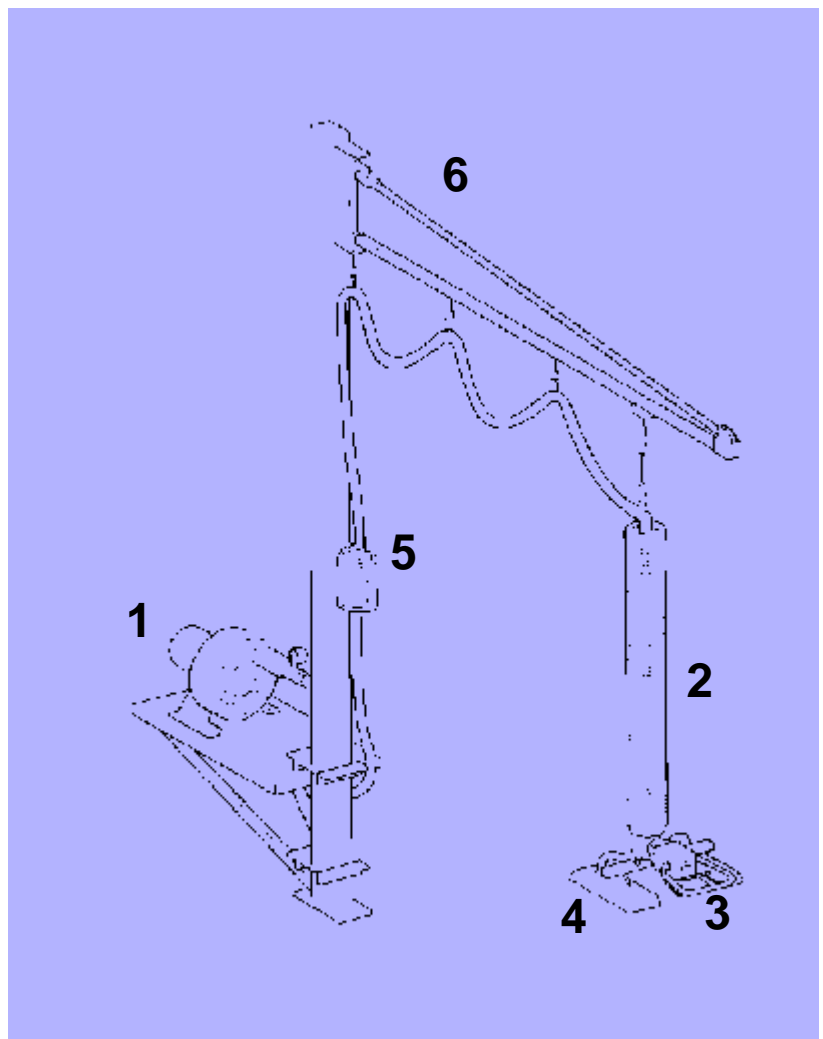

**Blower**  
 SKE 2,2-0070

**Blower**  
 SKV 3,3-0070

**Blower**  
 SKV 4,0-0120

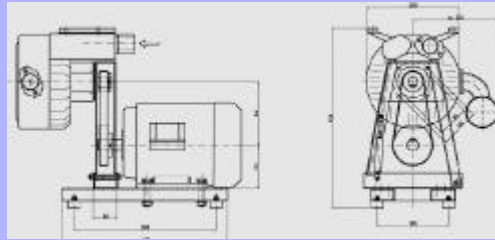

Vacuum Blowers

**Lifting Unit**  
 HE 100

**Lifting Unit**  
 HE 120

**Lifting Unit**  
 HE 140

**Lifting Unit**  
 HE 160

**Lifting Unit**  
 HE 180

**Lifting Unit**  
 HE 200

**Lifting Unit**  
 HE 230

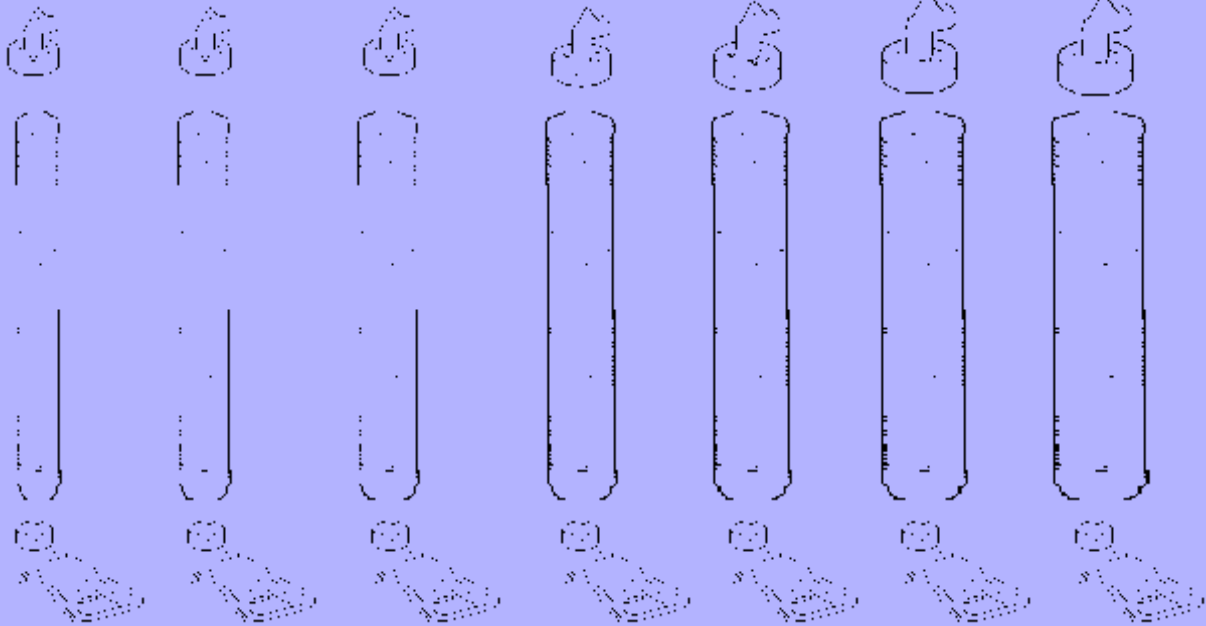

Lifting Unit with Control Housing

**Single Suction Feet**

**Sack Suction Feet**

**Double Suction Feet**

**Fourfold Suction Feet**



Suction Feet

**Dust Filter**

**Blower Hose**

**Spare Sealings**

**Mounting Plate**  
 for blowers

**Wall mounting and**  
 column slewing jib

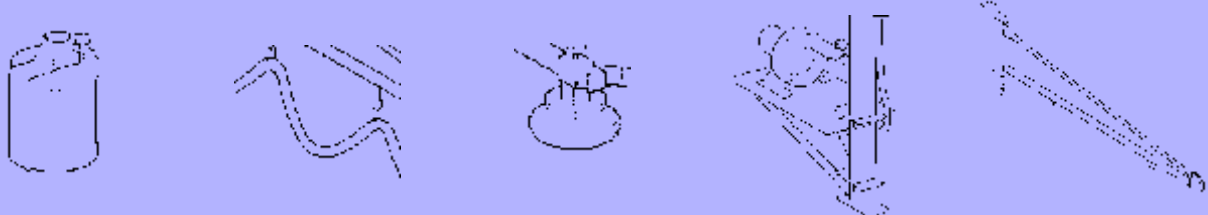

Accessories

Technical Data:			
Lift tube diameter	D	100 mm	
Max. carrying capacity:		30 / 25 kg*	
Lifting speed:		0 - 60 m/min	
Complete height:	F	2.750 mm + HS	4.250 mm + HS
Lift tube length:	A	2.500 mm	4.000 mm
Blocked dimension:	G	800 mm	1.500 mm
Max. lift	H	1.700 mm	2.500 mm
Height suction head:	B	150 mm	150 mm
Height suspension:	E	100 mm	100 mm
Hose connection:	K	52 mm	52 mm
Height suction foot:	HS	see chart suction foot	
Min. suction area:	cm <sup>3</sup>	200 cm <sup>2</sup>	

\* Indication of carrying capacities for dense/porous materials

Complete Units incl. Blower, Dust Filter and Hose:		
Designation:	VPL 100/1700	VPL 100/1700
Vacuum pump / blower:	T 4.40	SKE 2,2-0070
Standard-Art.-No:	3.26.1.0002	3.26.1.0001
Old Art.-No:	261 000	261 001
Price Euro:	3.144,00 €	3.604,00 €

Lift 1.700 mm, without suction foot

Incl. Dust Filter Standard with mounting, hose (8 meter length)

Blower, Vacuum Pump:		
Designation:	T 4.40	SKE 2,2-0070
Type of material:	dense	porous
Tension:	230/400 V	230/400 V
Performance 50 / 60 Hz: kW	1,25	2,2
Degree of protection:		IP 54
Noise level dB(A):	67 dB(A)	unter 75 dB(A)
Weight: kg	38,5 kg	36 kg
Standard-Art.-No:	4.26.3.0022	4.26.3.0008
Old Art.-No:	264 700	264729
Price Euro:	1.749,00 €	2.137,00 €

Ex-proof blowers and non-standard tension see page: 17 / 18

Lifting Unit without Control housing:			
Designation:	HE 100/1700	HE 100/2500	
Lift tube length:	A	2.500 mm	4.000 mm
Max. lift:	H	1.700 mm	2.500 mm
Length control housing:	L1	250 mm	250 mm
Weight:	kg		
Standard-Art.-No:	4.26.1.0012	4.26.1.0013	
Old Art.-No:	261 050	261 051	
Price Euro:	793,00 €	869,00 €	
Stainless st.-Art.-No:			
Old Art.-No:	271 050	271 051	
Price Euro:	on request	on request	

Control housing and Extensions:					
Designation:	Control Housing		Extensions		
	SGK	SGD	VS 250	VS 500	VG 200
Description:	L2 moving gripp	turnable gripp	rigid	rigid	joint
Length:	L3 250 mm	200 mm	250 mm	500 mm	200 mm
Weight:	kg				
Standard-Art.-No:	4.26.2.0005	4.26.2.0004	4.26.2.0007	4.26.2.0008	4.26.2.0006
Old Art.-No:	264 600	264 601	264 602	264 603	264 604
Price Euro:	363,00 €	363,00 €	64,00 €	89,50 €	222,00 €
Stainless st.-Art.-No:					
Old Art.-No:	274 600	274 601	274 602	274 603	274 604
Price Euro:	on request	on request	on request	on request	on request

Dimension of control housing				
	L1	L2	H1	H2
SGK	250	---	---	---
SGD	150	---	---	---
SGK + VS 250	500	250	---	---
SGD + VS 250	400	200	---	---
SGK + VS 500	750	500	---	---
SGD + VS 500	650	500	---	---
SGK + VG 200	450	200	250	250
SGD + VG 200	350	200	180	180
SGK + VS250/VG	600	250	425	425
SGD + VS250/VG	500	250	350	350

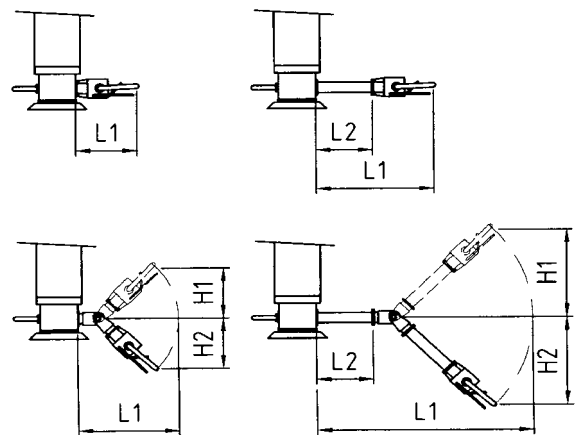
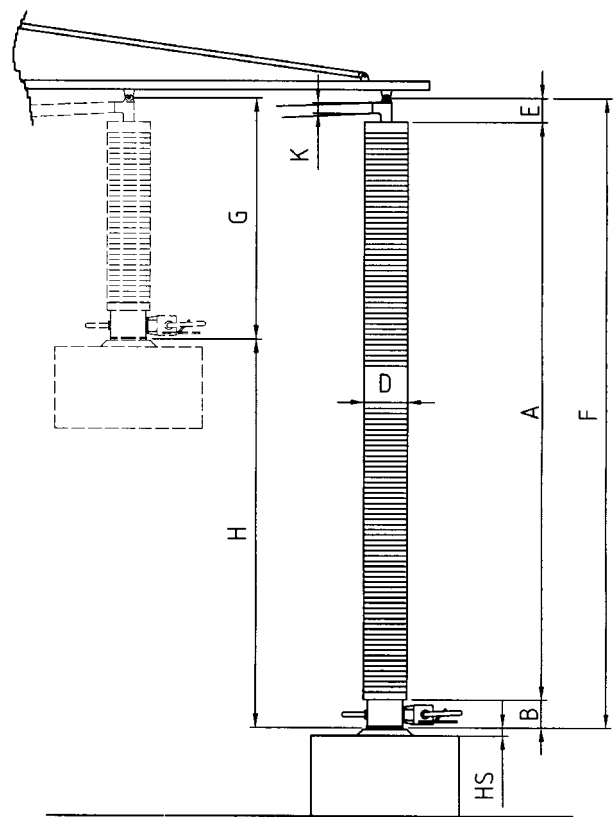

Single Suction Foot SFE-		Sack		Sack*	
Designation		200 FBS	200 V	190x290K	180x370M
Length suction foot	LS/DS	200	200	290	370
Width suction foot	BS	---	---	190	180
Height suction foot	HS	60	35	85	100
Suction area	cm <sup>3</sup>	280	300	385	660
Weight	kg				
<b>Standard-Art.-No.:</b>		4.26.5.0020	4.26.5.0021	4.26.5.0031	4.26.5.0030
old Art.-No.:		265 000	265 002	265 010	265 013
Price Euro:		235,00 €	146,00 €	299,00 €	360,00 €
<b>Stainless st.-Art.-No.:</b>					
old Art.-No.:		275 000	275 002		275 013
Price Euro:		on request	on request	on request	on request

\* incl. Adapter plate and counter gasket

Bellow-Type Suction Foot      Round Suction Foot      Sack Suction Foot

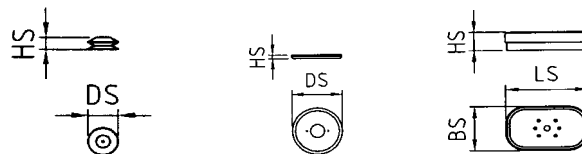

made of sheet metal  
or plastic

Double Suction Foot SFD 85x200 /					
Designation		400	800	1200	1800
Length suction foot	LS	210	210	210	210
Width suction foot	BS	85	85	85	85
Height suction foot	HS	100	100	100	100
Longitudinal beam	L1	400	800	1200	1800
Distance min/max.	L2/L3	130 / 410	130 / 810	130 / 1210	130 / 1810
Suction area	cm <sup>3</sup>	340	340	340	340
Weight	kg				
<b>Standard-Art.-No.:</b>		4.26.5.0015	4.26.5.0016	4.26.5.0013	4.26.5.0014
old Art.-No.:		265 015	265 016	265 017	265 018
Price Euro:		381,00 €	391,00 €	401,00 €	417,00 €
<b>Stainless st.-Art.-No.:</b>					
old Art.-No.:		275 015	275 016	275 017	275 018
Price Euro:		on request	on request	on request	on request

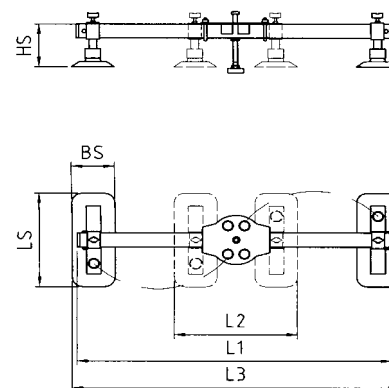

Fourfold Suction Foot SFV 115 FBS /					
Designation		400 / 400	800 / 400	1200 / 800	1800 / 800
Length suction foot	LS	115	115	115	115
Width suction foot	BS	---	---	---	---
Height suction foot	HS	140	140	140	140
Longitudinal beam	L1	400	800	1200	1800
Cross beam	B1	400	400	800	800
Dist. Length min/max	B2/B3	350 / 520	350 / 920	350 / 1320	350 / 1920
Dist. Cross min/max	L2/L3	120 / 460	120 / 460	120 / 860	120 / 860
Suction area	cm <sup>3</sup>	380	380	380	400
Weight	kg				
<b>Standard-Art.-No.:</b>		4.26.5.0036	4.26.5.0037	4.26.5.0034	4.26.5.0035
old Art.-No.:		265 043	265 044	265 045	265 046
Price Euro:		703,00 €	713,00 €	744,00 €	759,00 €
<b>Stainless st.-Art.-No.:</b>					
old Art.-No.:		275 043	275 044	275 045	275 046
Price Euro:		on request	on request	on request	on request

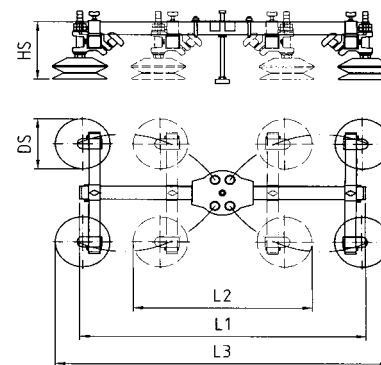

Accessories:			Standard-Model			Stainless steel model		
Designation			Art.-No.:	old Art.-No.:	Price Euro	Art.-No.:	old Art.-No.:	Price Euro
Silencer	SD	for blower SVE 2,2 up to SVE 4,0	4.26.4.0037	264 739	43,00 €			
Blower hose	VS-52	Connecting for lifting unit per meter	5.26.4.0017	264 804	12,70 €		274 804	on request
Dust filter standard	SF-S	incl. Filter cartridge and mounting set	4.26.4.0012	264 800	141,00 €			
Dust filter big	SF-G	incl. Filter cartridge and mounting set	4.26.4.0011	264 801	176,00 €			
Quick-change coupl.	SWK-O 100/160	one for suction head / System 100/160	4.26.4.0019	264 900	84,40 €		274 900	on request
Quick-change coupl.	SWK-U 100/160	for each suction foot / System 100/160	4.26.4.0021	264 901	74,20 €		274 901	on request
Rotation unit	DV 100/160	for endless swivelling of loads	4.26.4.0001	264 904	268,00 €		274 904	on request
Swivelling unit 90°	WA 100/160	for manual swivelling of loads	4.26.4.0024	264 906	268,00 €		274 906	on request
Additional Handle	ZHG	for mounting on suction foot	4.26.4.0028	264 605	74,20 €		274 605	on request

Further accessories page 17 ff

Wall-mounted and column slewing jibs see page 22 ff

Technical Data:			
Lift tube diameter	D	120 mm	
Max. carrying capacity:		40 / 35 kg*	
Lifting speed:		0 - 60 m/min	
Complete height:	F	2.750 mm + HS	4.250 mm + HS
Lift tube length:	A	2.500 mm	4.000 mm
Blocked dimension:	G	800 mm	1.500 mm
Max. lift	H	1.700 mm	2.500 mm
Height suction head:	B	150 mm	150 mm
Height suspension:	E	100 mm	100 mm
Hose connection:	K	52 mm	52 mm
Height suction foot:	HS	see chart suction foot	
Min. suction area:	cm <sup>3</sup>	280 cm <sup>2</sup>	

\* Indication of carrying capacities for dense/porous materials

Complete Units incl. Blower, Dust Filter and Hose:		
Designation:	VPL 120/1700	VPL 120/1700
Vacuum pump / blower:	SKE 2,2-0070	SKE 3,0-0070
Standard-Art.-Nr:	3.26.1.0005	3.26.1.0006
Alte Art.-Nr.	261 200	261 201
Preis Euro:	3.717,00 €	3.870,00 €

Lift 1.700 mm, without suction foot

Incl. Dust Filter Standard with mounting, hose (8 meter length)

Blower, Vacuum Pump:		
Designation:	SKE 2,2-0070	SKE 3,0-0070
Type of material:	dense / slightly porous	very porous
Tension:	230/400 V	
Performance 50 / 60 Hz: kW	2,2	3,0
Degree of protection:	IP 54	IP 54
Noise level dB(A):	< 75 dB(A)	< 75 dB(A)
Weight: kg	36 kg	42 kg
Standard-Art.-No:	4.26.3.0008	4.26.3.0009
old Art.-Nr:	264 729	264 730
Price Euro:	2.137,00 €	2.219,00 €

Ex-proof blowers and non-standard tension see page: 17 / 18

Lifting Unit without Control housing:		
Designation:	HE 100/1700	HE 100/2500
Lift tube length:	A 2.500 mm	4.000 mm
Max. lift:	H 1.700 mm	2.500 mm
Length control housing:	L1 250 mm	250 mm
Weight: kg		
Standard-Art.-No:	4.26.1.0014	4.26.1.0015
old Art.-Nr:	261 250	261 251
Price Euro:	905,00 €	982,00 €
Stainless st.-Art.-No:		
old Art.-Nr:	271 250	271 251
Price Euro:	on request	on request

Control housing and Extensions:					
Designation:	Control Housing		Extensions		
	SGK	SGD	VS 250	VS 500	VG 200
Description:	L2 moving gripp	turnable gripp	rigid	rigid	joint
Length:	L3 250 mm	200 mm	250 mm	500 mm	200 mm
Weight:	kg				
Standard-Art.-No:	4.26.2.0005	4.26.2.0004	4.26.2.0007	4.26.2.0008	4.26.2.0006
old Art.-Nr:	264 600	264 601	264 602	264 603	264 604
Price Euro:	363,00 €	363,00 €	64,00 €	89,50 €	222,00 €
Stainless st.-Art.-No:					
old Art.-Nr:	274 600	274 601	274 602	274 603	274 604
Price Euro:	on request	on request	on request	on request	on request

Dimension of control housing				
	L1	L2	H1	H2
SGK	250	---	---	---
SGD	150	---	---	---
SGK + VS 250	500	250	---	---
SGD + VS 250	400	200	---	---
SGK + VS 500	750	500	---	---
SGD + VS 500	650	500	---	---
SGK + VG 200	450	200	250	250
SGD + VG 200	350	200	180	180
SGK + VS250/VG	600	250	425	425
SGD + VS250/VG	500	250	350	350

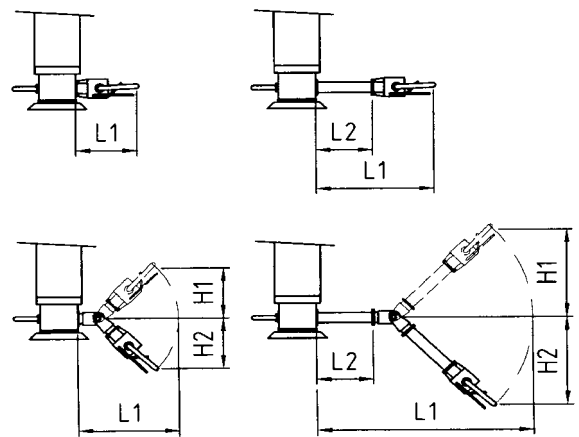
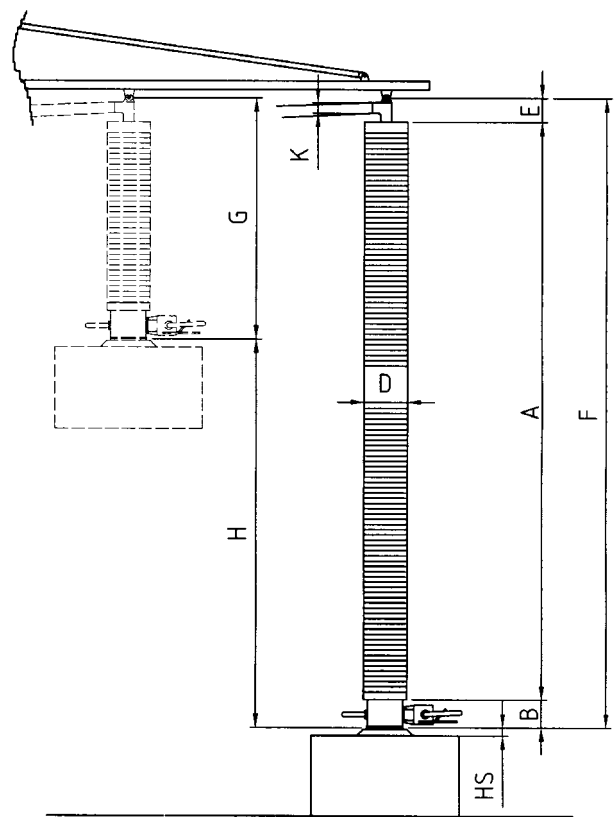

Single Suction Foot SFE-		Sack			Sack*	
Designation		250 FBS	200 V	120x320	190x290K	180x370M
Length suction foot	LS/DS	250	200	200	290	370
Width suction foot	BS	---	---	---	190	180
Height suction foot	HS	65	35	30	85	100
Suction area	cm <sup>3</sup>	450	300	380	385	660
Weight	kg					
<b>Standard-Art.-No.:</b>		4.26.5.0023	4.26.5.0021	4.26.5.0017	4.26.5.0031	4.26.5.0030
old Art.-Nr.:		265 001	265 002	265 007	265 010	265 013
Price Euro:		245,00 €	146,00 €	171,00 €	299,00 €	360,00 €
<b>Stainless st.-Art.-No.:</b>						
old Art.-Nr.:		275 001	275 002	275 007		275 013
Price Euro:		auf Anfrage	auf Anfrage	auf Anfrage	auf Anfrage	auf Anfrage

\* incl. Adapter plate and counter gasket

Bellow-Type Suction Foot

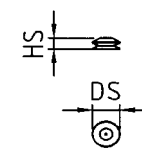

Round Suction Foot

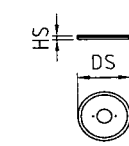

Rectangular Suction Foot

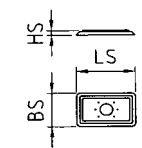

Sack Suction Foot

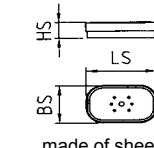

made of sheet metal  
or plastic

Double Suction Foot SFD 85x200 /		400	800	1200	1800
Length suction foot	LS	210	210	210	210
Width suction foot	BS	85	85	85	85
Height suction foot	HS	140	140	140	140
Longitudinal beam	L1	400	800	1200	1800
Distance min/max.	L2/L3	130 / 410	130 / 410	130 / 410	130 / 410
Suction area	cm <sup>3</sup>	340	340	340	340
Weight	kg				
<b>Standard-Art.-No.:</b>		4.26.5.0015	4.26.5.0016	4.26.5.0013	4.26.5.0014
old Art.-Nr.:		265 015	265 016	265 017	265 018
Price Euro:		381,00 €	391,00 €	401,00 €	417,00 €
<b>Stainless st.-Art.-No.:</b>					
old Art.-Nr.:		275 015	275 016	275 017	275 018
Price Euro:		on request	on request	on request	on request

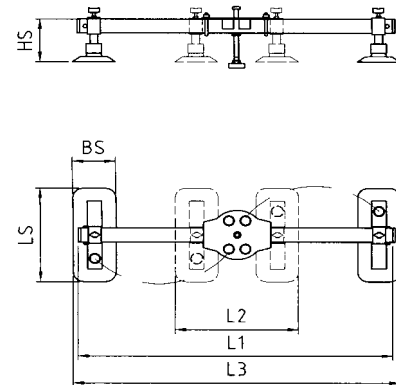

Fourfold Suction Foot SFV 115 FBS /		400 / 400	800 / 400	1200 / 800	1800 / 800
Length suction foot	LS	115	115	115	115
Width suction foot	BS	---	---	---	---
Height suction foot	HS	140	140	140	140
Longitudinal beam	L1	400	800	1200	1800
Cross beam	B1	400	400	800	800
Dist. Length min/max	B2/B3	350 / 520	350 / 920	350 / 1320	350 / 1920
Dist. Cross min/max	L2/L3	120 / 460	120 / 460	120 / 860	120 / 860
Suction area	cm <sup>3</sup>	380	380	380	380
Weight	kg				
<b>Standard-Art.-No.:</b>		4.26.5.0036	4.26.5.0037	4.26.5.0034	4.26.5.0035
old Art.-Nr.:		265 043	265 044	265 045	265 046
Price Euro:		703,00 €	713,00 €	744,00 €	759,00 €
<b>Stainless st.-Art.-No.:</b>					
old Art.-Nr.:		275 043	275 044	275 045	275 046
Price Euro:		on request	on request	on request	on request

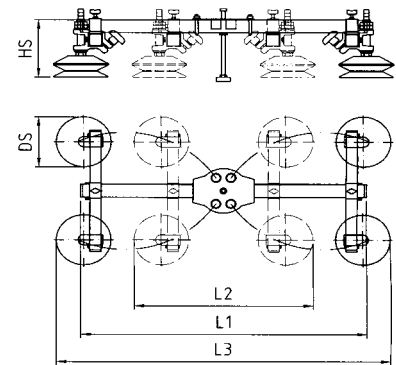

Accessories:		Standard-Model			Stainless steel model		
Designation		Art.-No.:	old Art.-No.:	Price Euro	Art.-No.:	old Art.-No.:	Price Euro
Silencer	SD	for blower SVE 2,2 up to SVE 4,0	4.26.4.0037	264 739	43,00 €		
Blower hose	VS-52	Connecting for lifting unit per meter	5.26.4.0017	264 804	12,70 €		
Dust filter standard	SF-S	incl. Filter cartridge and mounting set	4.26.4.0012	264 800	141,00 €	274 804	on request
Dust filter big	SF-G	incl. Filter cartridge and mounting set	4.26.4.0011	264 801	176,00 €		
Quick-change coupl.	SWK-O 100/160	one for suction head / System 100/160	4.26.4.0019	264 900	84,40 €	274 900	on request
Quick-change coupl.	SWK-U 100/160	for each suction foot / System 100/160	4.26.4.0021	264 901	74,20 €	274 901	on request
Rotation unit	DV 100/160	for endless swivelling of loads	4.26.4.0001	264 904	268,00 €	274 904	on request
Swivelling unit 90°	WA 100/160	for manual swivelling of loads	4.26.4.0024	264 906	268,00 €	274 906	on request
Additional Handle	ZHG	for mounting on suction foot	4.26.4.0028	264 605	74,20 €	274 605	on request

Further accessories page 17 ff

Wall-mounted and column slewing jibs see page 22 ff

Technical Data:			
Lift tube diameter	D	140 mm	
Max. carrying capacity:		50 / 45 kg*	
Lifting speed:		0 - 50 m/min	
Complete height:	F	2.750 mm+ HS	4.250 mm + HS
Lift tube length:	A	2.500 mm	4.000 mm
Blocked dimension:	G	800 mm	1.500 mm
Max. lift	H	1.700 mm	2.500 mm
Height suction head:	B	150 mm	150 mm
Height suspension:	E	100 mm	100 mm
Hose connection:	K	52 mm	52 mm
Height suction foot:	HS	see chart suction foot	
Min. suction area:	cm <sup>3</sup>	385 cm <sup>2</sup>	

\* Indication of carrying capacities for dense/porous materials

Complete Units incl. Blower, Dust Filter and Hose:		
Designation:	VPL 140/1700	VPL 140/1700
Vacuum pump / blower:	SKE 2,2-0070	SKE 3,0-0070
Standard-Art.-No:	3.26.1.0008	3.26.1.0009
old Art.-Nr:	261 400	261 401
Price Euro:	3.768,00 €	3.921,00 €

Lift 1.700 mm, without suction foot

Incl. Dust Filter Standard with mounting, hose (8 meter length)

Blower, Vacuum Pump:		
Designation:	SKE 2,2-0070	SKE 3,0-0070
Type of material:	dense / slightly porous	very porous
Tension:	230/400 V	
Performance 50 / 60 Hz: kW	2,2	3,0
Degree of protection:	IP 54	IP 54
Noise level dB(A):	< 75 dB(A)	< 75 dB(A)
Weight: kg	36 kg	42 kg
Standard-Art.-No:	4.26.3.0008	4.26.3.0009
old Art.-Nr:	264 729	264 730
Price Euro:	2.137,00 €	2.219,00 €

Ex-proof blowers and non-standard tension see page: 17 / 18

Lifting Unit without Control housing:			
Designation:	HE 140/1700	HE 140/2500	
Lift tube length:	A	2.500 mm	4.000 mm
Max. lift:	H	1.700 mm	2.500 mm
Length control housing:	L1	250 mm	250 mm
Weight: kg			
Standard-Art.-No:	4.26.1.0016	4.26.1.0017	
old Art.-Nr:	261 450	261 451	
Price Euro:	956,00 €	1.043,00 €	
Stainless st.-Art.-No:			
old Art.-Nr:	271 450	271 451	
Price Euro:	on request	on request	

Control housing and Extensions:					
Designation:	Control Housing		Extensions		
	SGK	SGD	VS 250	VS 500	VG 200
Description:	L2 moving gripp	turnable gripp	rigid	rigid	joint
Length:	L3 250 mm	200 mm	250 mm	500 mm	200 mm
Weight: kg					
Standard-Art.-No:	4.26.2.0005	4.26.2.0004	4.26.2.0007	4.26.2.0008	4.26.2.0006
old Art.-Nr:	264 600	264 601	264 602	264 603	264 604
Price Euro:	363,00 €	363,00 €	64,00 €	89,50 €	222,00 €
Stainless st.-Art.-No:					
old Art.-Nr:	274 600	274 601	274 602	274 603	274 604
Price Euro:	on request	on request	on request	on request	on request

Dimension of control housing				
	L1	L2	H1	H2
SGK	250	---	---	---
SGD	150	---	---	---
SGK + VS 250	500	250	---	---
SGD + VS 250	400	200	---	---
SGK + VS 500	750	500	---	---
SGD + VS 500	650	500	---	---
SGK + VG 200	450	200	250	250
SGD + VG 200	350	200	180	180
SGK + VS250/VG	600	250	425	425
SGD + VS250/VG	500	250	350	350

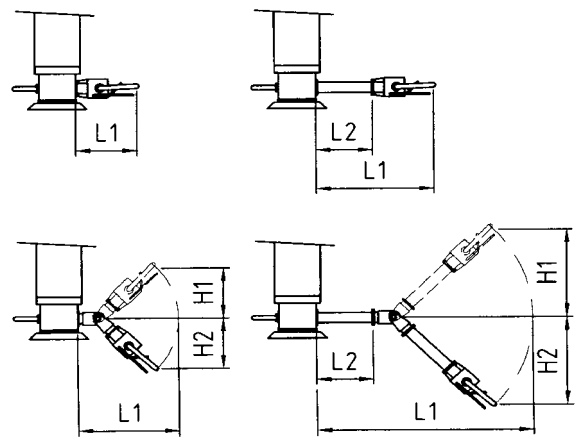
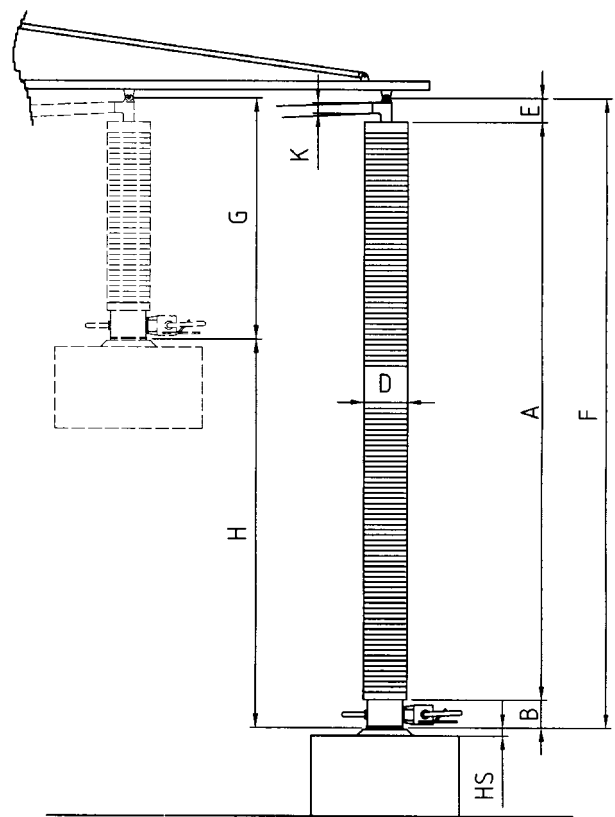

Single Suction Foot SFE-		Sack				Sack*
Designation		250 V	120x320	140x380	190x290K	180x370M
Length suction foot	LS/DS	250	320	380	290	370
Width suction foot	BS	---	120	140	190	180
Height suction foot	HS	35	30	30	85	100
Suction area	cm <sup>3</sup>	500	380	530	385	660
Weight	kg					
<b>Standard-Art.-No.:</b>		4.26.5.0025	4.26.5.0017	4.26.5.0019	4.26.5.0031	4.26.5.0030
old Art.-No.:		265103	265 007	265 108	265 010	265 013
Price Euro:		228,00 €	171,00 €	248,00 €	299,00 €	360,00 €
<b>Stainless st.-Art.-No.:</b>						
old Art.-No.:		275 103	275 007	275 108		275 013
Price Euro:		on request	on request	on request	on request	on request

\* incl. Adapter plate and counter gasket

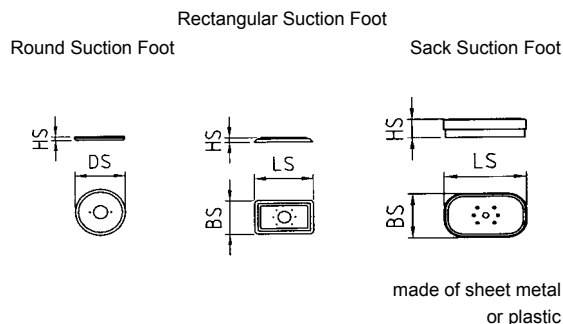

Double Suction Foot SFD 120x320 /					
Designation		400	800	1200	1800
Length suction foot	LS	320	320	320	320
Width suction foot	BS	120	120	120	120
Height suction foot	HS	100	100	100	100
Longitudinal beam	L1	400	800	1200	1800
Distance min/max.	L2/L3	200 / 430	200 / 430	200 / 430	200 / 430
Suction area	cm <sup>3</sup>	760	760	760	760
Weight	kg				
<b>Standard-Art.-No.:</b>		4.26.5.0006	4.26.5.0008	4.26.5.0002	4.26.5.0004
old Art.-No.:		265 023	265 024	265 025	265 026
Price Euro:		463,00 €	473,00 €	483,00 €	499,00 €
<b>Stainless st.-Art.-No.:</b>					
old Art.-No.:		275 019	275 020	275 021	275 022
Price Euro:		on request	on request	on request	on request

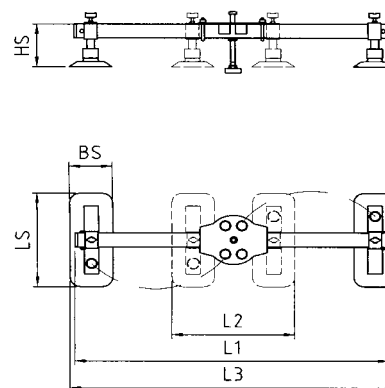

Fourfold Suction Foot SFV 85x200 /					
Designation		400 / 400	800 / 400	1200 / 800	1800 / 800
Length suction foot	LS	200	200	200	200
Width suction foot	BS	85	85	85	85
Height suction foot	HS	135	135	135	135
Longitudinal beam	L1	400	800	1200	1800
Cross beam	B1	400	400	800	800
Dist. Length min/max	B2/B3	400 / 540	400 / 940	400 / 1340	400 / 1940
Dist. Cross min/max	L2/L3	170 / 425	170 / 425	170 / 825	170 / 825
Suction area	cm <sup>3</sup>	680	680	680	680
Weight	kg				
<b>Standard-Art.-No.:</b>		4.26.5.0050	4.26.5.0053	4.26.5.0044	4.26.5.0047
old Art.-No.:		265 135	265 136	265 137	265 138
Price Euro:		856,00 €	867,00 €	897,00 €	913,00 €
<b>Stainless st.-Art.-No.:</b>					
old Art.-No.:		275 135	275 136	275 137	275 138
Price Euro:		on request	on request	on request	on request

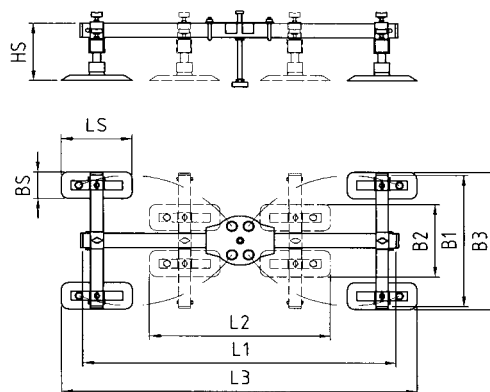

Accessories:			Standard-Model			Stainless steel model		
Designation			Art.-No.:	old Art.-No.:	Price Euro	Art.-No.:	old Art.-No.:	Price Euro
Silencer	SD	for blower SVE 2,2 up to SVE 4,0	4.26.4.0037	264 739	43,00 €			
Blower hose	VS-52	Connecting for lifting unit per meter	5.26.4.0017	264 804	12,70 €		274 804	on request
Dust filter standard	SF-S	incl. Filter cartridge and mounting set	4.26.4.0012	264 800	141,00 €			
Dust filter big	SF-G	incl. Filter cartridge and mounting set	4.26.4.0011	264 801	176,00 €			
Quick-change coupl.	SWK-O 100/160	one for suction head / System 100/160	4.26.4.0019	264 900	84,40 €		274 900	on request
Quick-change coupl.	SWK-U 100/160	for each suction foot / System 100/160	4.26.4.0021	264 901	74,20 €		274 901	on request
Rotation unit	DV 100/160	for endless swivelling of loads	4.26.4.0001	264 904	268,00 €		274 904	on request
Swivelling unit 90°	WA 100/160	for manual swivelling of loads	4.26.4.0024	264 906	268,00 €		274 906	on request
Additional Handle	ZHG	for mounting on suction foot	4.26.4.0028	264 605	74,20 €		274 605	on request

Further accessories page 17 ff

Wall-mounted and column slewing jibs see page 22 ff

Technical Data:			
Lift tube diameter	D	160 mm	
Max. carrying capacity:		65 / 60 kg*	
Lifting speed:		0 - 50 m/min	
Complete height:	F	2.750 mm+ HS	4.250 mm + HS
Lift tube length:	A	2.500 mm	4.000 mm
Blocked dimension:	G	800 mm	1.500 mm
Max. lift	H	1.700 mm	2.500 mm
Height suction head:	B	150 mm	150 mm
Height suspension:	E	100 mm	100 mm
Hose connection:	K	52 mm	52 mm
Height suction foot:	HS	see chart suction foot	
Min. suction area:	cm <sup>3</sup>	500 cm <sup>2</sup>	

\* Indication of carrying capacities for dense/porous materials

Complete Units incl. Blower, Dust Filter and Hose:			
Designation:	VPL 160/1700	VPL 160/1700	
Vacuum pump / blower:	SKE 2,2-0070	SKE 3,0-0070	
Standard-Art.-No:	3.26.1.0012	3.26.1.0014	
old Art.-Nr:	261 600	261 601	
Price Euro:	3.804,00 €	3.957,00 €	

Lift 1.700 mm, without suction foot

Incl. Dust Filter Standard with mounting, hose (8 meter length)

Blower, Vacuum Pump:			
Designation:	SKE 2,2-0070	SKE 3,0-0070	
Type of material:	dense	slightly / very porous	
Tension:		230/400 V	
Performance 50 / 60 Hz:	kW	2,2	3,0
Degree of protection:		IP 54	IP 54
Noise level dB(A):		< 75 dB(A)	< 75 dB(A)
Weight:	kg	36 kg	42 kg
Standard-Art.-No:	4.26.3.0008	4.26.3.0009	
old Art.-Nr:	264 729	264 730	
Price Euro:	2.137,00 €	2.219,00 €	

Ex-proof blowers and non-standard tension see page: 17 / 18

Lifting Unit without Control housing:			
Designation:	HE 160/1700	HE 160/2500	
Lift tube length:	A	2.500 mm	4.000 mm
Max. lift:	H	1.700 mm	2.500 mm
Length control housing:	L1	250 mm	250 mm
Weight:	kg		
Standard-Art.-No:	4.26.1.0018	4.26.1.0019	
old Art.-Nr:	261 650	261 651	
Price Euro:	992,00 €	1.099,00 €	
Stainless st.-Art.-No:			
old Art.-Nr:	271 650	271 651	
Price Euro:	on request		on request

Control housing and Extensions:					
Designation:	Control Housing		Extensions		
	SGK	SGD	VS 250	VS 500	VG 200
Description:	L2 moving gripp	turnable gripp	rigid	rigid	joint
Length:	L3 250 mm	200 mm	250 mm	500 mm	200 mm
Weight:	kg				
Standard-Art.-No:	4.26.2.0005	4.26.2.0004	4.26.2.0007	4.26.2.0008	4.26.2.0006
old Art.-Nr:	264 600	264 601	264 602	264 603	264 604
Price Euro:	363,00 €	363,00 €	64,00 €	89,50 €	222,00 €
Stainless st.-Art.-No:					
old Art.-Nr:	274 600	274 601	274 602	274 603	274 604
Price Euro:	on request	on request	on request	on request	on request

Dimension of control housing				
	L1	L2	H1	H2
SGK	250	---	---	---
SGD	150	---	---	---
SGK + VS 250	500	250	---	---
SGD + VS 250	400	200	---	---
SGK + VS 500	750	500	---	---
SGD + VS 500	650	500	---	---
SGK + VG 200	450	200	250	250
SGD + VG 200	350	200	180	180
SGK + VS250/VG	600	250	425	425
SGD + VS250/VG	500	250	350	350

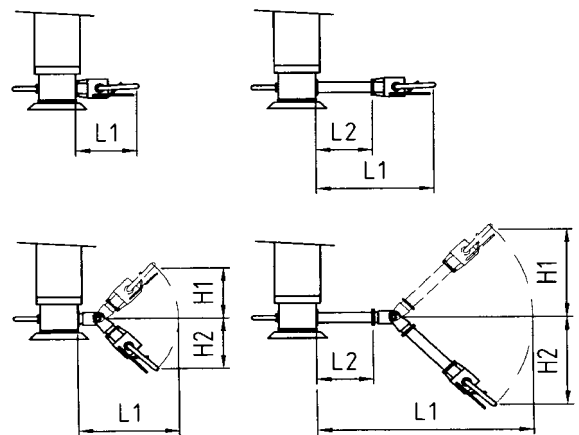
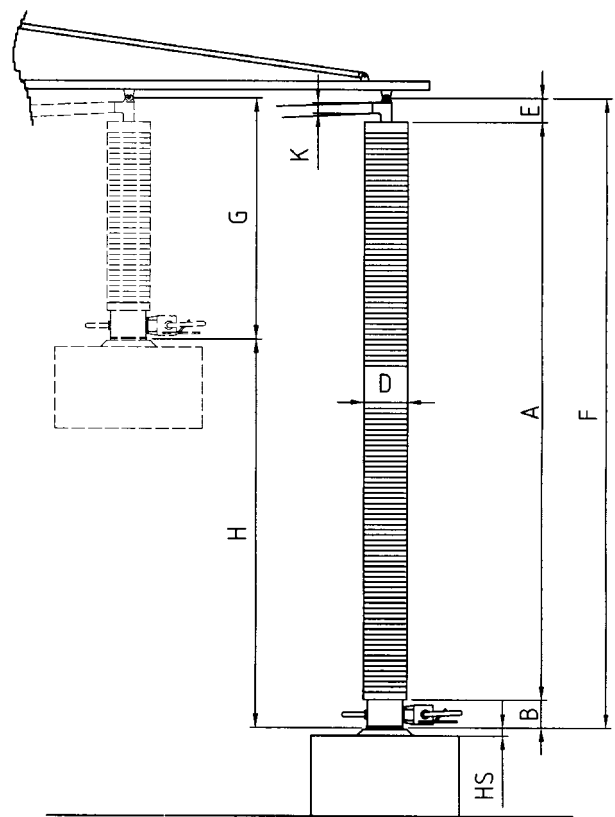

Single Suction Foot SFE-		Sack*		Sack*	
Designation		250 V	140x380	230x380K	180x370M
Length suction foot	LS/DS	250	200	380	370
Width suction foot	BS	---	---	230	180
Height suction foot	HS	35	30	100	85
Suction area	cm <sup>3</sup>	500	530	635	660
Weight	kg				
<b>Standard-Art.-No.:</b>		4.26.5.0024	4.26.5.0018	4.26.5.0033	4.26.5.0029
old Art.-Nr.:		265 003	265 008	265 014	265 011
Price Euro:		166,00 €	187,00 €	320,00 €	291,00 €
<b>Stainless st.-Art.-No.:</b>					
old Art.-Nr.:		275 003	275 008		275 011
Price Euro:		on request	on request	on request	on request

\* incl. Adapter plate and counter gasket

Round Suction Foot      Rectangular Suction Foot      Sack Suction Foot

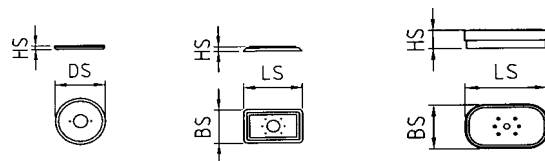

made of plastic

Double Suction Foot SFD 120x320 /					
Designation		400	800	1200	1800
Length suction foot	LS	320	320	320	320
Width suction foot	BS	120	120	120	120
Height suction foot	HS	100	100	100	100
Longitudinal beam	L1	400	800	1200	1800
Distance min/max.	L2/L3	200 / 430	200 / 430	200 / 430	200 / 430
Suction area	cm <sup>3</sup>	760	760	760	760
Weight	kg				
<b>Standard-Art.-No.:</b>		4.26.5.0005	4.26.5.0007	4.26.5.0001	4.26.5.0003
old Art.-Nr.:		265 019	265 020	265 021	265 022
Price Euro:		401,00 €	412,00 €	422,00 €	437,00 €
<b>Stainless st.-Art.-No.:</b>					
old Art.-Nr.:		275 019	275 020	275 021	275 022
Price Euro:		on request	on request	on request	on request

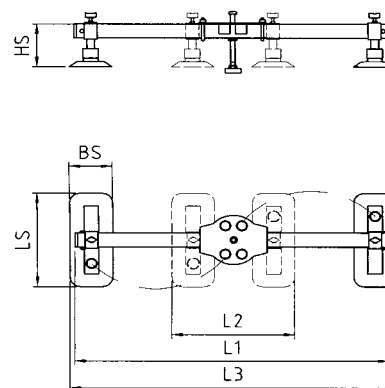

Fourfold Suction Foot SFV 85x200 /					
Designation		400 / 400	800 / 400	1200 / 800	1800 / 800
Length suction foot	LS	200	200	200	200
Width suction foot	BS	85	85	85	85
Height suction foot	HS	135	135	135	135
Longitudinal beam	L1	400	800	1200	1800
Cross beam	B1	400	400	800	800
Dist. Length min/max	B2/B3	400 / 540	400 / 940	400 / 1340	400 / 1940
Dist. Cross min/max	L2/L3	170 / 425	170 / 425	170 / 825	170 / 825
Suction area	cm <sup>3</sup>	680	680	680	680
Weight	kg				
<b>Standard-Art.-No.:</b>		4.26.5.0048	4.26.5.0051	4.26.5.0042	4.26.5.0045
old Art.-Nr.:		265 035	265 036	265 037	265 038
Price Euro:		795,00 €	805,00 €	836,00 €	851,00 €
<b>Stainless st.-Art.-No.:</b>					
old Art.-Nr.:		275 035	275 036	275 037	275 038
Price Euro:		on request	on request	on request	on request

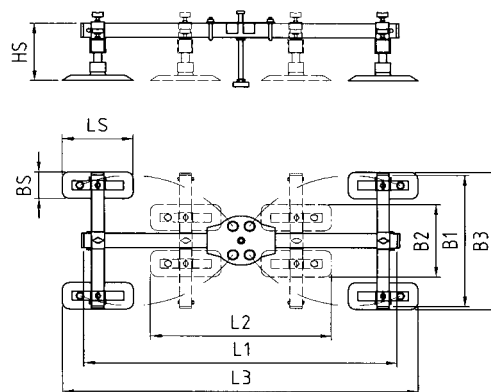

Accessories:			Standard-Model			Stainless steel model		
Designation			Art.-No.:	old Art.-Nr.:	Price Euro	Art.-No.:	old Art.-Nr.:	Price Euro
Silencer	SD	for blower SVE 2,2 up to SVE 4,0	4.26.4.0037	264 739	43,00 €			
Blower hose	VS-52	Connecting for lifting unit per meter	5.26.4.0017	264 804	12,70 €		274 804	on request
Dust filter standard	SF-S	incl. Filter cartridge and mounting set	4.26.4.0012	264 800	141,00 €			
Dust filter big	SF-G	incl. Filter cartridge and mounting set	4.26.4.0011	264 801	176,00 €			
Quick-change coupl.	SWK-O 100/160	one for suction head / System 160/180	4.26.4.0020	264 902	89,50 €		274 902	on request
Quick-change coupl.	SWK-U 100/160	for each suction foot / System 160/168	4.26.4.0022	264 903	79,30 €		274 903	on request
Rotation unit	DV 100/160	for endless swivelling of loads	4.26.4.0002	264 905	289,00 €		274 905	on request
Swivelling unit 90°	WA 100/160	for manual swivelling of loads	4.26.4.0025	264 907	289,00 €		274 907	on request
Additional Handle	ZHG	for mounting on suction foot	4.26.4.0028	264 605	289,00 €		274 605	on request

Further accessories page 17 ff

Wall-mounted and column slewing jibs see page 22 ff

Technical Data:			
Lift tube diameter	D	180 mm	
Max. carrying capacity:		85 / 80 kg*	
Lifting speed:		0 - 80 m/min	
Complete height:	F	2.750 mm+ HS	4.250 mm + HS
Lift tube length:	A	2.500 mm	4.000 mm
Blocked dimension:	G	800 mm	1.500 mm
Max. lift	H	1.700 mm	2.500 mm
Height suction head:	B	150 mm	150 mm
Height suspension:	E	100 mm	100 mm
Hose connection:	K	52 mm	52 mm
Height suction foot:	HS	see chart suction foot	
Min. suction area:	cm <sup>3</sup>	635 cm <sup>2</sup>	

\* Indication of carrying capacities for dense/porous materials

Complete Units incl. Blower, Dust Filter and Hose:		
Designation:	VPL 180/1700	VPL 180/1700
Vacuum pump / blower:	SKE 3,0-0070	SKE 4,0-0120
Standard-Art.-No:	3.26.1.0018	3.26.1.0019
old Art.-Nr:	261 800	261 801
Price Euro:	4.105,00 €	4.821,00 €

Lift 1.700 mm, without suction foot

Incl. Dust Filter Standard with mounting, hose (8 meter length)

Blower, Vacuum Pump:		
Designation:	SKE 3,0-0070	SKE 4,0-0120
Type of material:	dense / slightly porous	very porous
Tension:	230/400 V	
Performance 50 / 60 Hz: kW	3,0	3,0
Degree of protection:	IP 54	IP 54
Noise level dB(A):	unter 75 dB(A)	unter 75 dB(A)
Weight: kg	42 kg	52 kg
Standard-Art.-No:	4.26.3.0009	4.26.3.0010
old Art.-Nr:	264 730	264 731
Price Euro:	2.219,00 €	3.022,00 €

Ex-proof blowers and non-standard tension see page: 17 / 18

Lifting Unit without Control housing:			
Designation:	HE 180/1700	HE 180/2500	
Lift tube length:	A	2.500 mm	4.000 mm
Max. lift:	H	1.700 mm	2.500 mm
Length control housing:	L1	250 mm	250 mm
Weight: kg			
Standard-Art.-No:	4.26.1.0020	4.26.1.0021	
old Art.-Nr:	261 850	261 851	
Price Euro:	1.140,00 €	1.268,00 €	
Stainless st.-Art.-No:			
old Art.-Nr:	263 182	263 183	
Price Euro:	on request	on request	

Control housing and Extensions:					
Designation:	Control Housing		Extensions		
	SGK	SGD	VS 250	VS 500	VG 200
Description:	L2 moving gripp	turnable gripp	rigid	rigid	joint
Length:	L3 250 mm	200 mm	250 mm	500 mm	200 mm
Weight:	kg				
Standard-Art.-No:	4.26.2.0005	4.26.2.0004	4.26.2.0007	4.26.2.0008	4.26.2.0006
old Art.-Nr:	264 600	264 601	264 602	264 603	264 604
Price Euro:	363,00 €	363,00 €	64,00 €	89,50 €	222,00 €
Stainless st.-Art.-No:					
old Art.-Nr:	274 600	274 601	274 602	274 603	274 604
Price Euro:	on request	on request	on request	on request	on request

Dimension of control housing				
	L1	L2	H1	H2
SGK	250	---	---	---
SGD	150	---	---	---
SGK + VS 250	500	250	---	---
SGD + VS 250	400	200	---	---
SGK + VS 500	750	500	---	---
SGD + VS 500	650	500	---	---
SGK + VG 200	450	200	250	250
SGD + VG 200	350	200	180	180
SGK + VS250/VG	600	250	425	425
SGD + VS250/VG	500	250	350	350

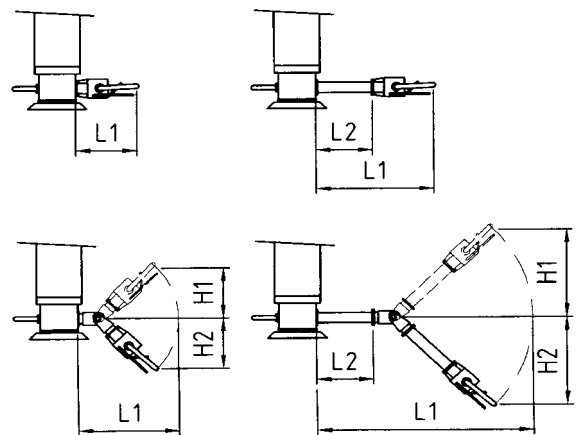
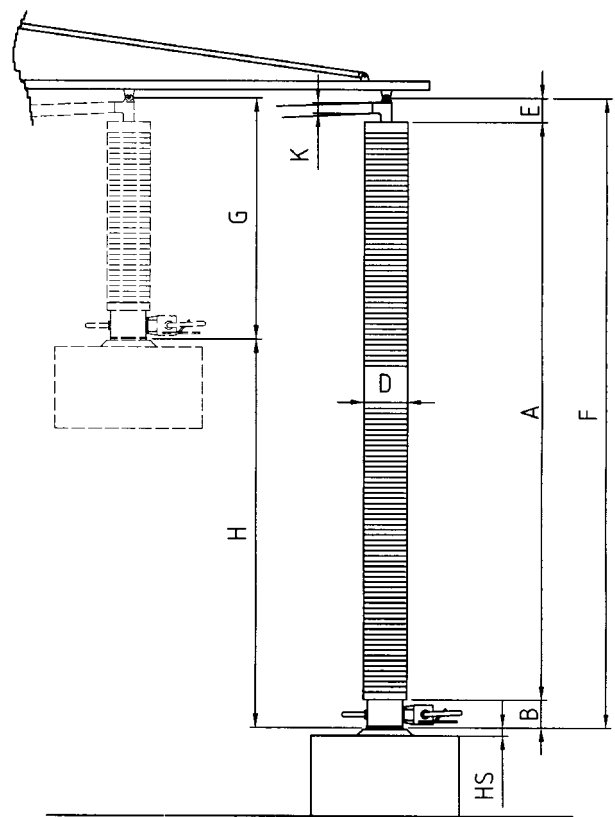

Single Suction Foot SFE-		Sack		Sack	
Designation		320 V	200x320	230x380K	180x370M
Length suction foot	LS/DS	320	320	380	370
Width suction foot	BS	---	200	230	180
Height suction foot	HS	35	35	100	85
Suction area	cm <sup>3</sup>	800	640	635	660
Weight	kg				
<b>Standard-Art.-No.:</b>		4.26.5.0026	4.26.5.0022	4.26.5.0033	4.26.5.0029
old Art.-Nr.:		265 004	265 009	265 014	265 011
Price Euro:		197,00 €	187,00 €	320,00 €	291,00 €
<b>Stainless st.-Art.-No.:</b>					
old Art.-Nr.:		275 004	275 009		275 011
Price Euro:		on request	on request		on request

Round Suction Foot    Rectangular Suction Foot    Sack Suction Foot

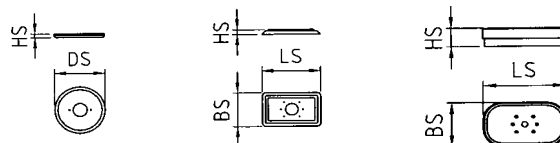

made of plastic

\* incl. Adapter plate and counter gasket

Double Suction Foot SFD 120x320 /					
Designation		400	800	1200	1800
Length suction foot	LS	320	320	320	320
Width suction foot	BS	120	120	120	120
Height suction foot	HS	100	100	100	100
Longitudinal beam	L1	400	800	1200	1800
Distance min/max.	L2/L3	200 / 430	200 / 430	200 / 430	200 / 430
Suction area	cm <sup>3</sup>	760	760	760	760
Weight	kg				
<b>Standard-Art.-No.:</b>		4.26.5.0005	4.26.5.0007	4.26.5.0001	4.26.5.0003
old Art.-Nr.:		265 019	265 020	265 021	265 022
Price Euro:		401,00 €	412,00 €	422,00 €	437,00 €
<b>Stainless st.-Art.-No.:</b>					
old Art.-Nr.:		275 019	275 020	275 021	275 022
Price Euro:		on request	on request	on request	on request

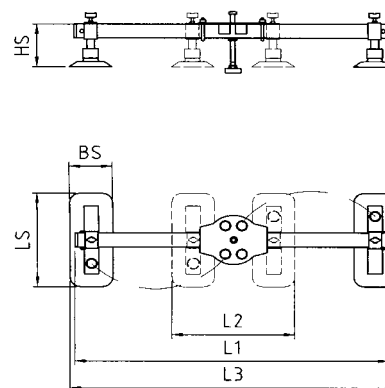

Fourfold Suction Foot SFV 85x200 /					
Designation		400 / 400	800 / 400	1200 / 800	1800 / 800
Length suction foot	LS	200	200	200	200
Width suction foot	BS	85	85	85	85
Height suction foot	HS	135	135	135	135
Longitudinal beam	L1	400	800	1200	1800
Cross beam	B1	400	400	800	800
Dist. Length min/max	B2/B3	400 / 540	400 / 940	400 / 1340	400 / 1940
Dist. Cross min/max	L2/L3	170 / 425	170 / 425	170 / 825	170 / 825
Suction area	cm <sup>3</sup>	680	680	680	680
Weight	kg				
<b>Standard-Art.-No.:</b>		4.26.5.0048	4.26.5.0051	4.26.5.0042	4.26.5.0045
old Art.-Nr.:		265 035	265 036	265 037	265 038
Price Euro:		795,00 €	805,00 €	836,00 €	851,00 €
<b>Stainless st.-Art.-No.:</b>					
old Art.-Nr.:		275 035	275 036	275 037	275 038
Price Euro:		on request	on request	on request	on request

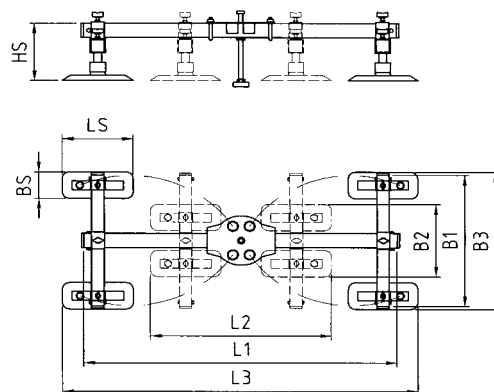

Accessories:			Standard-Model			Stainless steel model		
Designation			Art.-No.:	old Art.-Nr.:	Price Euro	Art.-No.:	old Art.-Nr.:	Price Euro
Silencer	SD	for blower SVK 2,2 up to SVK 4,0	4.26.4.0037	264 739	43,00 €			
Blower hose	VS-52	Connecting for lifting unit per meter	5.26.4.0017	264 804	12,70 €		274 804	on request
Dust filter standard	SF-S	incl. Filter cartridge and mounting set	4.26.4.0012	264 800	141,00 €			
Dust filter big	SF-G	incl. Filter cartridge and mounting set	4.26.4.0011	264 801	176,00 €			
Quick-change coupl.	SWK-O 180/230	one for suction head / System 180/230	4.26.4.0020	264 902	89,50 €		274 902	on request
Quick-change coupl.	SWK-U 180/230	for each suction foot / System 180/230	4.26.4.0022	264 903	79,30 €		274 903	on request
Rotation unit	DV 180/230	for endless swivelling of loads	4.26.4.0002	264 905	289,00 €		274 905	on request
Swivelling unit 90°	WA 180/230	for manual swivelling of loads	4.26.4.0025	264 907	289,00 €		274 907	on request
Additional Handle	ZHG	for mounting on suction foot	4.26.4.0028	264 605	289,00 €		274 605	on request

Further accessories page 17 ff

Wall-mounted and column slewing jibs see page 22 ff

Technical Data:			
Lift tube diameter	D	200 mm	
Max. carrying capacity:		110 / 100 kg*	
Lifting speed:		0 - 60 m/min	
Complete height:	F	2.750 mm+ HS	4.250 mm + HS
Lift tube length:	A	2.500 mm	4.000 mm
Blocked dimension:	G	800 mm	1.500 mm
Max. lift	H	1.700 mm	2.500 mm
Height suction head:	B	150 mm	150 mm
Height suspension:	E	100 mm	100 mm
Hose connection:	K	52 mm	52 mm
Height suction foot:	HS	see chart suction foot	
Min. suction area:	cm <sup>3</sup>	785 cm <sup>2</sup>	

\* Indication of carrying capacities for dense/porous materials

Complete Units incl. Blower, Dust Filter and Hose:		
Designation:	VPL 200/1700	VPL 200/1700
Vacuum pump / blower:	SKE 3,0-0070	SKE 4,0-0120
Standard-Art.-No:	3.26.1.0023	3.26.1.0024
old Art.-Nr:	262 000	262 001
Price Euro:	4.386,00 €	5.102,00 €

Lift 1.700 mm, without suction foot

Incl. Dust Filter Standard with mounting, hose (8 meter length)

Blower, Vacuum Pump:		
Designation:	SKE 3,0-0070	SKE 4,0-0120
Type of material:	dense/slightly porous	very porous
Tension:	230/400 V	
Performance 50 / 60 Hz: kW	3,0	3,0
Degree of protection:	IP 54	IP 54
Noise level dB(A):	< 75 dB(A)	< 75 dB(A)
Weight: kg	42 kg	52 kg
Standard-Art.-No:	4.26.3.0009	4.26.3.0010
old Art.-Nr:	264 730	264 731
Price Euro:	2.219,00 €	3.022,00 €

Ex-proof blowers and non-standard tension see page: 17 / 18

Lifting Unit without Control housing:			
Designation:	HE 200/1700	HE 200/2500	
Lift tube length:	A	2.500 mm	4.000 mm
Max. lift:	H	1.700 mm	2.500 mm
Length control housing:	L1	250 mm	250 mm
Weight: kg			
Standard-Art.-No:	4.26.1.0022	4.26.1.0023	
old Art.-Nr:	262 050	262 051	
Price Euro:	1.421,00 €	1.595,00 €	
Stainless st.-Art.-No:			
old Art.-Nr:	263 202	263 203	
Price Euro:	on request	on request	

Control housing and Extensions:					
Designation:	Control Housing		Extensions		
	SGK	SGD	VS 250	VS 500	VG 200
Description:	L2 moving gripp	turnable gripp	rigid	rigid	joint
Length:	L3 250 mm	200 mm	250 mm	500 mm	200 mm
Weight:	kg				
Standard-Art.-No:	4.26.2.0005	4.26.2.0004	4.26.2.0007	4.26.2.0008	4.26.2.0006
old Art.-Nr:	264 600	264 601	264 602	264 603	264 604
Price Euro:	363,00 €	363,00 €	64,00 €	89,50 €	222,00 €
Stainless st.-Art.-No:					
old Art.-Nr:	274 600	274 601	274 602	274 603	274 604
Price Euro:	on request	on request	on request	on request	on request

Dimension of control housing				
	L1	L2	H1	H2
SGK	250	---	---	---
SGD	150	---	---	---
SGK + VS 250	500	250	---	---
SGD + VS 250	400	200	---	---
SGK + VS 500	750	500	---	---
SGD + VS 500	650	500	---	---
SGK + VG 200	450	200	250	250
SGD + VG 200	350	200	180	180
SGK + VS250/VG	600	250	425	425
SGD + VS250/VG	500	250	350	350

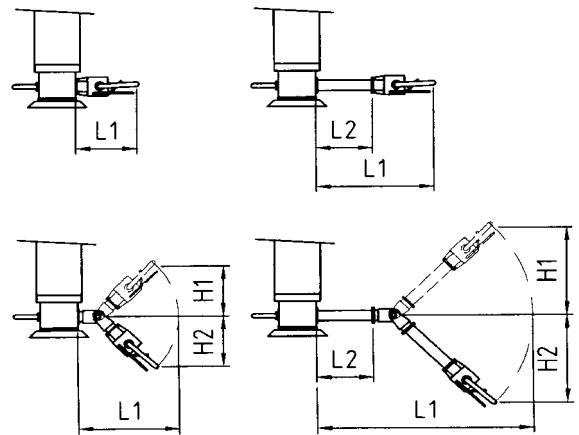
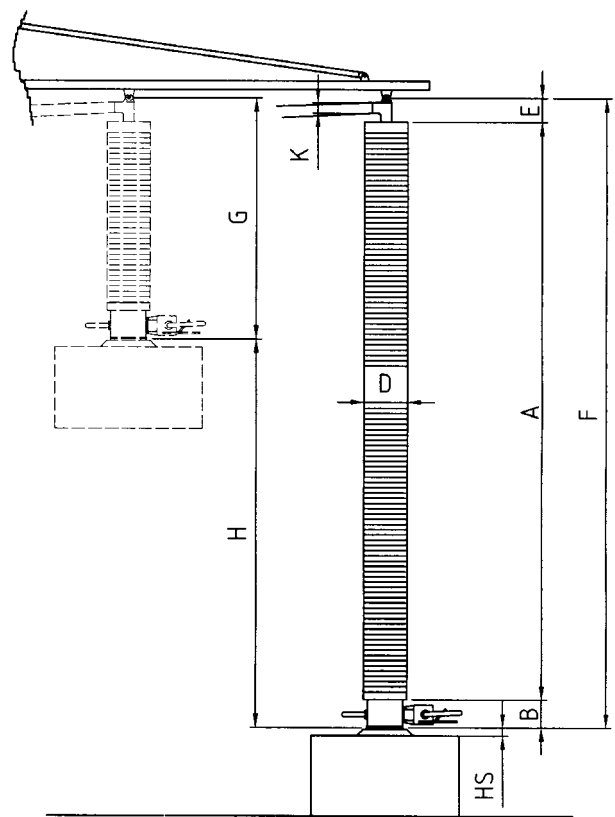

Single Suction Foot SFE-		
Designation	320 V	Rectang.
Length suction foot	LS/DS	250
Width suction foot	BS	---
Height suction foot	HS	
Suction area	cm <sup>3</sup>	800
Weight	kg	
<b>Standard-Art.-No:</b>	4.26.5.0026	
old Art.-Nr:	265 004	
Price Euro:	197,00 €	on request
<b>Stainless st.-Art.-No:</b>		
old Art.-Nr:	275 004	
Price Euro:	on request	on request

\* incl. Adapter plate and counter gasket

Round Suction Foot

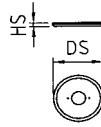

Rectangular Suction Foot

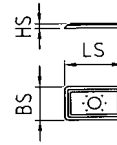

Double Suction Foot SFD 140x380 /					
Designation	400	800	1200	1800	
Length suction foot	LS	380	380	380	380
Width suction foot	BS	140	140	140	140
Height suction foot	HS	110	110	110	110
Longitudinal beam	L1	400	800	1200	1800
Distance min/max.	L2/L3	195 / 440	195 / 840	195 / 1240	195 / 1840
Suction area	cm <sup>3</sup>	1060	1060	1060	1060
Weight	kg				
<b>Standard-Art.-No:</b>	4.26.5.0011	4.26.5.0012	4.26.5.0009	4.26.5.0010	
old Art.-Nr:	265 027	265 028	265 029	265 030	
Price Euro:	447,00 €	463,00 €	478,00 €	501,00 €	
<b>Stainless st.-Art.-No:</b>					
old Art.-Nr:	275 027	275 028	275 029	275 030	
Price Euro:	on request	on request	on request	on request	

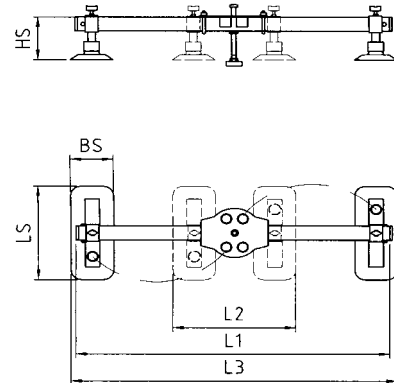

Fourfold Suction Foot SFV 120x320 /					
Designation	400 / 400	800 / 400	1200 / 800	1800 / 800	
Length suction foot	LS	320	320	320	320
Width suction foot	BS	120	120	120	120
Height suction foot	HS	155	155	155	155
Longitudinal beam	L1	400	800	1200	1800
Cross beam	B1	400	400	800	800
Dist. Length min/max	B2/B3	240 / 660	240 / 1060	240 / 1460	240 / 2060
Dist. Cross min/max	L2/L3	240 / 460	240 / 460	240 / 860	240 / 860
Suction area	cm <sup>3</sup>	1500	1500	1500	1500
Weight	kg				
<b>Standard-Art.-No:</b>	4.26.5.0040	4.26.5.0041	4.26.5.0038	4.26.5.0039	
old Art.-Nr:	265 039	265 040	265 041	265 042	
Price Euro:	851,00 €	867,00 €	913,00 €	936,00 €	
<b>Stainless st.-Art.-No:</b>					
old Art.-Nr:	275 039	275 040	275 041	275 042	
Price Euro:	on request	on request	on request	on request	

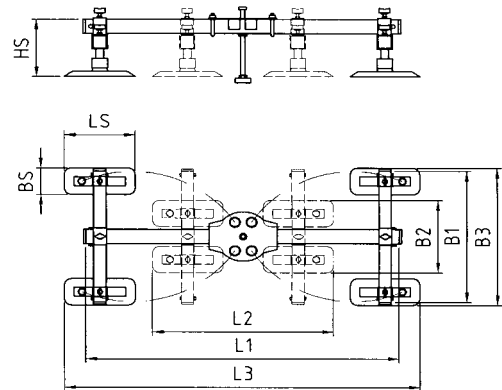

Accessories:			Standard-Model			Stainless steel model		
Designation			Art.-No:	Price DM	Price Euro	Art.-No:	Price DM	Price Euro
Silencer	SD	for blower SVE 2,2 up to SVE 4,0	4.26.4.0037	264 739	43,00 €			
Blower hose	VS-52	Connecting for lifting unit per meter	5.26.4.0017	264 804	12,70 €	274 804		on request
Dust filter standard	SF-S	incl. Filter cartridge and mounting set	4.26.4.0012	264 800	141,00 €			
Dust filter big	SF-G	incl. Filter cartridge and mounting set	4.26.4.0011	264 801	176,00 €			
Quick-change coupl.	SWK-O 180/230	one for suction head / System 180/230	4.26.4.0002	264 905	289,00 €	274 905		on request
Quick-change coupl.	SWK-U 180/230	for each suction foot / System 180/230	4.26.4.0025	264 907	289,00 €	274 907		on request
Rotation unit	DV 180/230	for endless swivelling of loads	4.26.4.0028	264 605	74,20 €	274 605		on request
Swivelling unit 90°	WA 180/230	for manual swivelling of loads						
Additional Handle	ZHG	for mounting on suction foot						
<b>Further accessories page 17 ff</b>			<b>Wall-mounted and column slewing jibs see page 22 ff</b>					

Technical Data:			
Lift tube diameter	D	230 mm	
Max. carrying capacity:		140 / 120 kg*	
Lifting speed:		0 - 50 m/min	
Complete height:	F	2.750 mm+ HS	4.250 mm + HS
Lift tube length:	A	2.500 mm	4.000 mm
Blocked dimension:	G	800 mm	1.500 mm
Max. lift	H	1.700 mm	2.500 mm
Height suction head:	B	150 mm	150 mm
Height suspension:	E	100 mm	100 mm
Hose connection:	K	52 mm	52 mm
Height suction foot:	HS	see chart suction foot	
Min. suction area:	cm <sup>3</sup>	1000 cm <sup>2</sup>	

\* Indication of carrying capacities for dense/porous materials

Complete Units incl. Blower, Dust Filter and Hose:		
Designation:	VPL 230/1700	VPL 230/1700
Vacuum pump / blower:	SKE 3,0-0070	SKE 4,0-0120
Standard-Art.-No:	3.26.1.0028	3.26.1.0030
old Art.-Nr:	262 300	262 301
Price Euro:	4.662,00 €	5.409,00 €

Lift 1.700 mm, without suction foot

Incl. Dust Filter Standard with mounting, hose (8 meter length)

Blower, Vacuum Pump:		
Designation:	SKE 3,0-0070	SKE 4,0-0120
Type of material:	dense	slightly / very porous
Tension:	230/400 V	
Performance 50 / 60 Hz: kW	3,0	3,0
Degree of protection:	IP 54	IP 54
Noise level dB(A):	y 75 dB(A)	< 75 dB(A)
Weight: kg	42 kg	52 kg
Standard-Art.-No:	4.26.3.0009	4.26.3.0010
old Art.-Nr:	264 730	264 731
Price Euro:	2.219,00 €	3.022,00 €

Ex-proof blowers and non-standard tension see page: 17 / 18

Lifting Unit without Control housing:			
Designation:	HE 230/1700	HE 230/2500	
Lift tube length:	A	2.500 mm	4.000 mm
Max. lift:	H	1.700 mm	2.500 mm
Length control housing:	L1	250 mm	250 mm
Weight: kg			
Standard-Art.-No:	4.26.1.0024	4.26.1.0025	
old Art.-Nr:	262 350	262 351	
Price Euro:	1.728,00 €	1.902,00 €	
Stainless st.-Art.-No:			
old Art.-Nr:	272 350	272 351	
Price Euro:	on request	on request	

Control housing and Extensions:					
Designation:	Control Housing		Extensions		
	SGK	SGD	VS 250	VS 500	VG 200
Description:	L2 moving gripp	turnable gripp	rigid	rigid	joint
Length:	L3 250 mm	200 mm	250 mm	500 mm	200 mm
Weight:	kg				
Standard-Art.-No:	4.26.2.0005	4.26.2.0004	4.26.2.0007	4.26.2.0008	4.26.2.0006
old Art.-Nr:	264 600	264 601	264 602	264 603	264 604
Price Euro:	363,00 €	363,00 €	64,00 €	89,50 €	222,00 €
Stainless st.-Art.-No:					
old Art.-Nr:	274 600	274 601	274 602	274 603	274 604
Price Euro:	on request	on request	on request	on request	on request

Dimension of control housing:				
	L1	L2	H1	H2
SGK	250	---	---	---
SGD	150	---	---	---
SGK + VS 250	500	250	---	---
SGD + VS 250	400	200	---	---
SGK + VS 500	750	500	---	---
SGD + VS 500	650	500	---	---
SGK + VG 200	450	200	250	250
SGD + VG 200	350	200	180	180
SGK + VS250/VG	600	250	425	425
SGD + VS250/VG	500	250	350	350

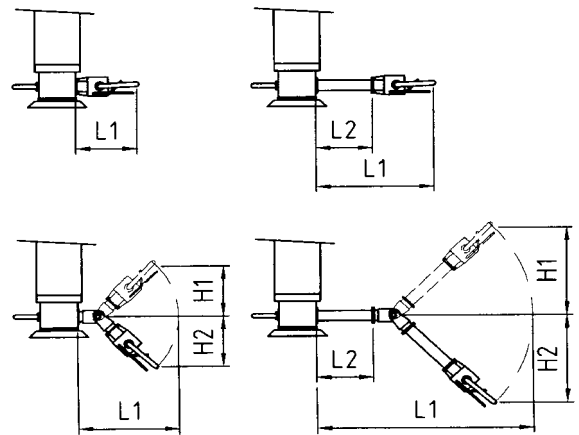
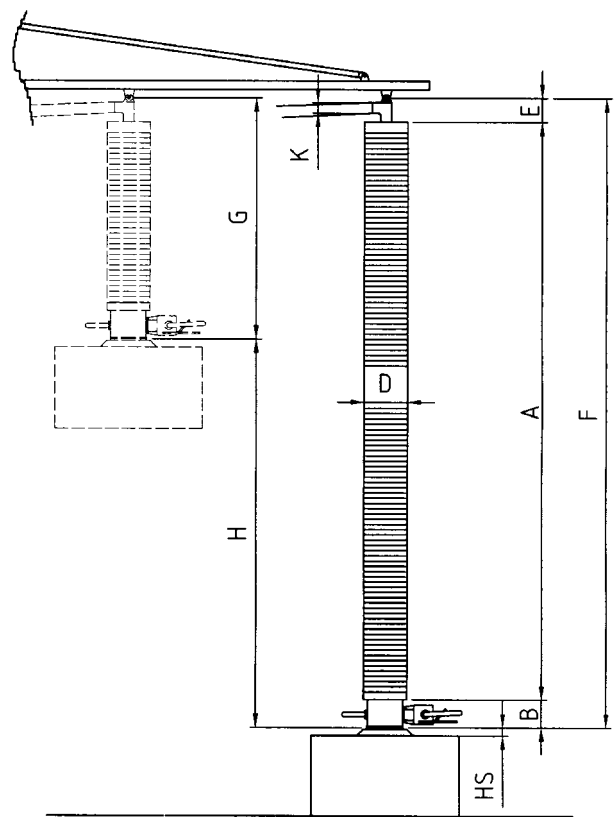

Single Suction Foot SFE-		
<b>Designation</b>	<b>360 V</b>	<b>Rectang.</b>
Length suction foot LS/DS	360	
Width suction foot BS	---	
Height suction foot HS	35	
Suction area cm <sup>3</sup>	1020	
Weight kg		
<b>Standard-Art.-No:</b>	4.26.5.0027	
old Art.-Nr:	265 005	
Price Euro:	238,00 €	
<b>Stainless st.-Art.-No:</b>		
old Art.-Nr:	275 005	
Price Euro:	on request	on request

Round Suction Foot

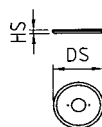

Rectangular Suction Foot

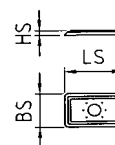

Double Suction Foot SFD 140x380 /					
<b>Designation</b>	<b>400</b>	<b>800</b>	<b>1200</b>	<b>1800</b>	
Length suction foot LS	380	380	380	380	
Width suction foot BS	140	140	140	140	
Height suction foot HS	110	110	110	110	
Longitudinal beam L1	400	800	1200	1800	
Distance min/max. L2/L3	195 / 440	195 / 840	195 / 1240	195 / 1840	
Suction area cm <sup>3</sup>	1060	1060	1060	1060	
Weight kg					
<b>Standard-Art.-No:</b>	4.26.5.0011	4.26.5.0012	4.26.5.0009	4.26.5.0010	
old Art.-Nr:	265 027	265 028	265 029	265 030	
Price Euro:	447,00 €	463,00 €	478,00 €	501,00 €	
<b>Stainless st.-Art.-No:</b>					
old Art.-Nr:	275 027	275 028	275 029	275 030	
Price Euro:	on request	on request	on request	on request	

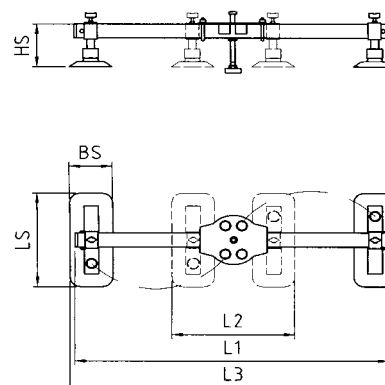

Fourfold Suction Foot SFV 120x320 /					
<b>Designation</b>	<b>400 / 400</b>	<b>800 / 400</b>	<b>1200 / 800</b>	<b>1800 / 800</b>	
Length suction foot LS	320	320	320	320	
Width suction foot BS	120	120	120	120	
Height suction foot HS	155	155	155	155	
Longitudinal beam L1	400	800	1200	1800	
Cross beam B1	400	400	800	800	
Dist. Length min/max B2/B3	240 / 660	240 / 1060	240 / 1460	240 / 2060	
Dist. Cross min/max L2/L3	240 / 460	240 / 460	240 / 860	240 / 860	
Suction area cm <sup>3</sup>	1500	1500	1500	1500	
Weight kg					
<b>Standard-Art.-No:</b>	4.26.5.0040	4.26.5.0041	4.26.5.0038	4.26.5.0039	
old Art.-Nr:	265 039	265 040	265 041	265 042	
Price Euro:	851,00 €	867,00 €	913,00 €	936,00 €	
<b>Stainless st.-Art.-No:</b>					
old Art.-Nr:	275 039	275 040	275 041	275 042	
Price Euro:	on request	on request	on request	on request	

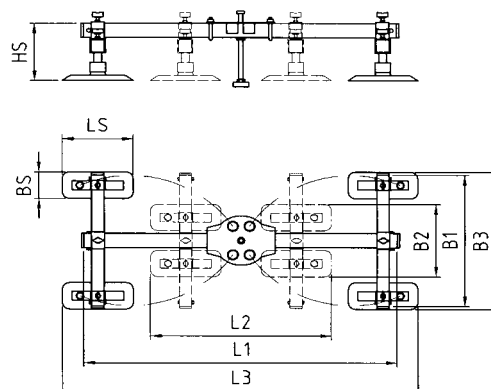

Accessories:			Standard-Model			Stainless steel model		
<b>Designation</b>			Art.-No:	old Art.-Nr:	Price Euro	Art.-No:	old Art.-Nr:	Price Euro
Silencer	SD	for blower SVE 2,2 up to SVE 4,0	4.26.4.0037	264 739	43,00 €			
Blower hose	VS-52	Connecting for lifting unit per meter	5.26.4.0017	264 804	12,70 €		274 804	auf Anfrage
Dust filter standard	SF-S	incl. Filter cartridge and mounting set	4.26.4.0012	264 800	141,00 €			
Dust filter big	SF-G	incl. Filter cartridge and mounting set	4.26.4.0011	264 801	176,00 €			
Rotation unit	DV 180/230	for endless swivelling of loads	4.26.4.0002	264 905	289,00 €		274 905	auf Anfrage
Swivelling unit 90°	WA 180/230	for manual swivelling of loads	4.26.4.0025	264 907	289,00 €		274 907	auf Anfrage
Additional Handle	ZHG	for mounting on suction foot	4.26.4.0028	264 605	74,20 €		274 605	auf Anfrage

Further accessories page 17 ff

Wall-mounted and column slewing jibs see page 22 ff

<b>Blower</b>		<b>Tension 200-240 / 345-415 V</b>				
Type:		<b>T 4.40</b>	<b>SKE 2,2 - 0070</b>	<b>SKE 3,0 - 0070</b>	<b>SKE 4,0 - 0120</b>	<b>SKE 5,5 - 0120</b>
Performance 50Hz:	kW	1,25 kW	2,2 kW	3,0 kW	4,0 kW	5,5 kW
Performance 60Hz:	IP	IP 55	IP 54	IP 54	IP 54	IP 54
Degree of protection	dB(A)	67 dB(A)	< 75 dB(A)	< 75 dB(A)	< 75 dB(A)	< 75 dB(A)
Noise level		39 kg	36 kg	42 kg	52 kg	57 kg
Weight:						
<b>Standard Art.-No:</b>		4.26.3.0022	4.26.3.0008	4.26.3.0009	4.26.3.0010	4.26.3.0011
old Art.-Nr:		264 700	264 729	264 730	264 731	264 732
Price Euro:		1.749,00 €	2.137,00 €	2.219,00 €	3.022,00 €	3.421,00 €

<b>Motor-protection switch with housing for mounting on blower</b>				
for blower:	T4.40	SKE 2,2	SKE 3,0	SKE 4,0
<b>Standard Art.-Nr:</b>	6.33.3.0007	6.33.3.0009	6.33.3.0011	6.33.3.0012
old Art.-Nr:	264 716	264 717	264 718	264 719
Preis Euro:	112,50 €	112,50 €	122,80 €	122,80 €

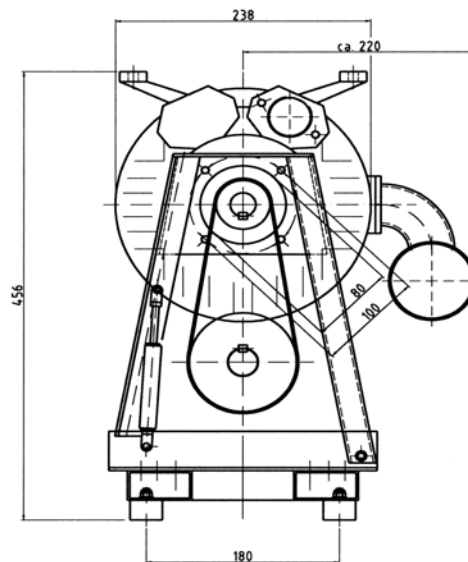
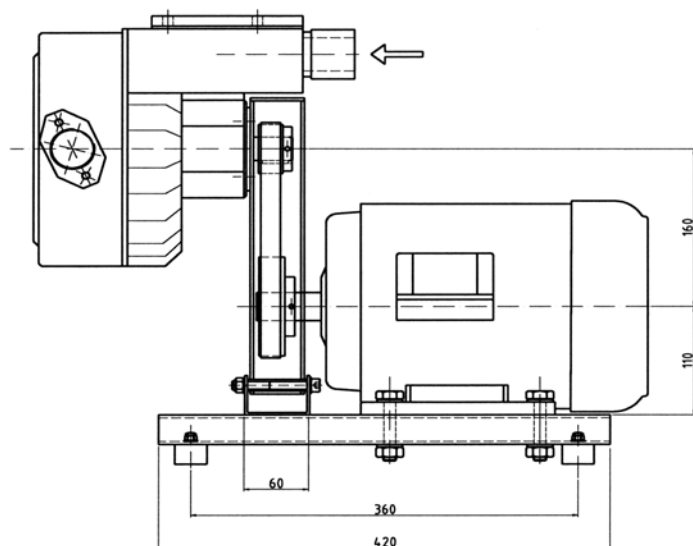

Mounting plate for installation of blower				
	without silencer box	with silencer box	without silencer box	with silencer box
Type:	KW-SKV	KW-SDB	KS-SKV	KS-SDB
Mounting on:	wall	wall	jib crane	jib crane
Bore configuration	2 x Bores 14 mm Distance 170 mm			
Dimensions LxBxH	400x325x320	800x580x320	400x325x320	800x580x320
Scope of delivery	2xHeavy-Duty Dowel M16x120		Clamping plate/Screws	
Weight:	kg			
<b>Standard Art.-Nr.:</b>	4.26.3.0005	4.26.3.0004	4.26.3.0003	4.26.3.0002
Alte Art.-Nr.	264 712	264 713	264 714	264 715
Preis Euro:	345,00 €	345,00 €	345,00 €	345,00 €

Radio telecontrol for blower with motor protection switch				
for blower:	SKV1,5/T4.40	SKV 2,2	SKV 3,3	SKV 4,0
Type:				
Voltage range:	400 V AC	400 V AC	400 V AC	400 V AC
Current consumption:	3,3 A	4,7 A	6,8 A	7,7 A
Weight transmitter:	0,1 kg	0,1 kg	0,1 kg	0,1 kg
Weight receiver:	0,1 kg	0,1 kg	0,1 kg	0,1 kg
<b>Standard Art.-Nr.:</b>	6.36.2.0001	6.36.2.0002	6.36.2.0003	6.36.2.0004
Alte Art.-Nr.	264 720	264 721	264 722	264 723
Preis Euro:	685,00 €	685,00 €	705,00 €	705,00 €

Vacuum gauge for mounting on outgoing of blower				
for blower:	SKV1,5/T4.40	SKV 2,2	SKV 3,3	SKV 4,0
Type:	VM 63 R1/4U		VM 100 R1/2U	
Indication range:	0 - 1000 mbar		0 - 1000 mbar	
Weight:	kg			
<b>Standard Art.-Nr.:</b>	4.26.3.0025		4.26.3.0024	
Alte Art.-Nr.	264 724		264 725	
Preis Euro:	50,60 €		71,00 €	

Silencer box for vacuum blower		
Designation:	SDB	SDB-K
Noise level:	without blower-installation	with blower-installation
Noise level:	Reduction of noise level for approx. 10 dB(A)	
Dimensions (L x W x H)	mm	
Scope of delivery:	Base plate with 4 bump rubbers	
Scope of delivery	direct on floor or on mounting plate	
Weight:	kg	
		plus blower
<b>Standard Art.-Nr.:</b>	4.26.3.0006	4.26.3.0007
Preis DM:	264 726	264 727
Preis Euro:	777,00 €	828,00 €

Connection- and spare hoses						
Type:	VS - 22 PVC	VS - 32 PUR	VS - 32 PVC	VS - 32 PUR	VS - 50 PVC	VS -50PUR
for connection of:	Suction foot	Suction foot	Suction foot	Suction foot	Blower	Blower
max. length:	10 m	10 m	10 m	10 m	16 m	16 m
Diameter:	22 mm	22 mm	32 mm	32 mm	50 mm	50 mm
Weight	kg/m					
<b>Standard Art.-No.:</b>	<b>264 802</b>	<b>274 802</b>	<b>264 803</b>	<b>274 803</b>	<b>264 804</b>	<b>274 804</b>
Price DM:	/m 18,00 DM	38,80 DM	22,00 DM	48,80 DM	24,80 DM	62,80 DM
Price Euro:	/m 9,20 €	19,84 €	11,25 €	24,95 €	12,68 €	32,11 €

\* incl. 2 hose clamps for hose fixing

Hose clamps and connection elements							
Type:	Hose - clamp	Hose - clamp	Hose - clamp	Connection straight	Connection straight	Connection T- Form	Connection T- Form
for diameter:	SS 22	SS 32	SS 50	VBS-22G	VBS-32G	VBS-22T	VBS-32T
Material	20 - 25 mm	30 - 35 mm	48 - 52 mm	22 mm	32 mm	22 mm	32 mm
Weight:				Plastic	Plastic	Plastic	Plastic
<b>Standard Art.-No.:</b>	<b>267 802</b>	<b>267 803</b>	<b>267 804</b>	<b>267 805</b>	<b>267 806</b>	<b>267 807</b>	<b>267 808</b>
Price DM:	1,40 DM	1,60 DM	3,80 DM	18,80 DM	22,80 DM	28,80 DM	32,80 DM
Price Euro:	0,72 €	0,82 €	1,94 €	9,61 €	11,66 €	14,73 €	16,77 €

Dust filter and filter cartridge				
Type:	Dust filter Standard	Dust filter Big	Filter cartridge Standard	Filter cartridge Big
Flow	SFS	SFG	FP-SFS	FP-SFG
Scope of delivery:	2 - 4,5 m³/h	3 - 6,5 m³/h		
Dimensions (DxH):	with mount for wall/column			
Bore distance:	200 x 355 mm	230 x 400 mm		
Weight:	190 mm	220 mm		
	1,7 kg	2,1 kg		
<b>Standard Art.-No.:</b>	<b>264 800</b>	<b>264 801</b>	<b>267 800</b>	<b>267 801</b>
Price DM:	275,00 DM	345,00 DM	93,80 DM	126,80 DM
Price Euro:	140,61 €	176,40 €	47,96 €	64,83 €

Quick-change coupling				
Type:	SWKO 100/160	SWKU 100/160	SWKO 180/230	SWKU 180/230
Connection side:	Suction head	Suction foot	Suction foot	Suction foot
for models:	VEL 100 - 160	VEL 100 - 160	VEL 180 - 230	VEL 180 - 230
Weight: kgs				
<b>Standard Art.-No:</b>	<b>264 900</b>	<b>264 901</b>	<b>264 902</b>	<b>264 903</b>
Price DM:	185,00 DM	145,00 DM	195,00 DM	155,00 DM
Price Euro:	94,59 €	74,14 €	99,70 €	79,25 €
<b>Stainless st. Art.-No:</b>	<b>274 900</b>	<b>274 901</b>	<b>274 902</b>	<b>274 904</b>
Price DM:	on request	on request	on request	on request
Price Euro:				

\* incl. counter gasket and connecting screws for suction head

Swivelling unit 360° endless		
Type:	DV 100/160	DV 180/230
Swivel angle	360° endlos	360° endlos
for models:	VEL 100 - 160	VEL 180 - 230
Weight: kg		
<b>Standard Art.-No:</b>	<b>264 904</b>	<b>264 905</b>
Price DM:	525,00 DM	545,00 DM
Price Euro:	268,43 €	278,65 €
<b>Stainless steel Art.-No:</b>	<b>274 904</b>	<b>274 905</b>
Price DM:	on request	on request
Price Euro:		

\* incl. counter gasket and connecting screws for suction head

Angle adapter 90°		
Type:	WA 100/160	WA 180/230
Swivel area:	90°	90°
for models:	VEL 100 - 160	VEL 180 - 230
Weight: kgs		
<b>Standard Art.-No:</b>	<b>264 906</b>	<b>264 907</b>
Price DM:	525,00 DM	545,00 DM
Price Euro:	268,43 €	278,65 €
<b>Stainless steel Art.-No:</b>	<b>274 906</b>	<b>274 907</b>
Price DM:	on request	on request
Price Euro:		

\* incl. counter gasket and connecting screws for suction head

Suction head extension				
Type:	STV 100/160	STV 100/160	STV 100/160	STV 100/160
	250	500	250	500
Extension:	250 mm	500 mm	250 mm	500 mm
for models:	VEL 100 - 160	VEL 100 - 160	VEL 180 - 230	VEL 180 - 230
Weight: kgs				
Weight: kgs				
<b>Standard Art.-No:</b>	<b>264 908</b>	<b>264 909</b>	<b>264 910</b>	<b>264 911</b>
Price DM:	465,00 DM	545,00 DM	485,00 DM	565,00 DM
Price Euro:	237,75 €	278,65 €	247,98 €	288,88 €
<b>Stainless steel Art.-No:</b>	<b>274 908</b>	<b>274 909</b>	<b>274 910</b>	<b>274 911</b>
Price DM:	on request	on request	on request	on request
Price Euro:				

\* incl. counter gasket and connecting screws for suction head

Protective cover for lift tube						
Type:	SÜH 100/120	SÜH 140	SÜH 160	SÜH 180	SÜH 200	SÜH 230
Material:	Nylon	Nylon	Nylon	Nylon	Nylon	Nylon
for models:	VEL 100/120	VEL 140	VEL 160	VEL 180	VEL 200	VEL 230
<b>Art.-No: Length 2.500</b>	<b>264 103</b>	<b>264 143</b>	<b>264 163</b>	<b>164 183</b>	<b>264 203</b>	<b>264 233</b>
Price DM:	148,00 DM	148,00 DM	148,00 DM	158,00 DM	158,00 DM	158,00 DM
Price Euro:	75,67 €	75,67 €	75,67 €	80,78 €	80,78 €	80,78 €
<b>Art.-No: Length 4.500</b>	<b>264 104</b>	<b>264 144</b>	<b>264 164</b>	<b>264 184</b>	<b>264 204</b>	<b>264 234</b>
Price DM:	1,00 DM	1,00 DM	1,00 DM	1,00 DM	1,00 DM	1,00 DM
Price Euro:	0,51 €	0,51 €	0,51 €	0,51 €	0,51 €	0,51 €

Control housing and options						
Type:	Control Housing		Extension	Extension	Extension	Additional
	Mouving Gripp	Turnable Gripp	250 rigid	500 rigid	250 joint	hand grip
Type:	SGK	SGD	VS 250	VS 500	VG 250	ZHG
Length:	150	250	250	750	250	180
Weight:						
<b>Standard Art.-No:</b>	<b>264 600</b>	<b>264 601</b>	<b>264 602</b>	<b>264 603</b>	<b>264 604</b>	<b>264 605</b>
Price Euro:	710,00 DM	710,00 DM	125,00 DM	175,00 DM	435,00 DM	145,00 DM
Price Euro:	363,02 €	363,02 €	63,91 €	89,48 €	222,41 €	74,14 €
<b>Stainless steel Art.-No:</b>	<b>274 600</b>	<b>274 601</b>	<b>274 602</b>	<b>274 603</b>	<b>274 604</b>	<b>274 605</b>
Price DM:	on request	on request	on request	on request	on request	on request
Price Euro:						

<b>Main and Cross beams</b>		
<b>Main beam incl. plate and counter gasket:</b>	<b>Art.No:</b>	<b>Price Euro</b>
main beam 30 x 400		171,00 €
main beam 30 x 800		182,00 €
main beam 30 x 1200		192,00 €
main beam 30 x 1800		207,00 €
main beam 30 x special lenght (basic price 200,00 DM zzgl.)		43,00 €
main beam 40 x 400		192,00 €
main beam 40 x 800		207,00 €
main beam 40 x 1200		222,00 €
main beam 40 x 1800		243,00 €
main beam 40 x Special lenght (basic price 200,00 DM zzgl.)		51,00 €
<b>Cross beam with thumb screw:</b>		
cross beam30 x 400		74,00 €
cross beam30 x 800		84,00 €
cross beam30 x special lenght (basic price 130,00 DM zzgl.)		41,00 €
cross beam40 x 400		79,00 €
cross beam40 x 800		95,00 €
cross beam40 x special lenght (basic price 130,00 DM zzgl.)		51,00 €
<b>Holder for suction foot with thumb screw:</b>		
Holder for suction foot on profile 30x30		18,00 €
Holder for suction foot on profile 40x40		18,00 €
Holder for bellow suction cup on profile 30x30		20,00 €

<b>Suction Foot Rectangular</b>		
<b>Designation</b>	<b>Art.No:</b>	<b>Price Euro</b>
suction foot 85x200 M		115,00 €
suction foot 120x320 M		125,00 €
suction foot 140x380 M		141,00 €

<b>Suction Foot with Bellow Suction Cup</b>		
<b>Designation</b>	<b>Art.No:</b>	<b>Price Euro</b>
bellow suction cup FBS 115		89,00 €
bellow suction cup FBS 200		182,00 €
bellow suction cup FBS 250		197,00 €

# Wall mounted slewing jibs

Profile System 85 mm and 125 mm

Designation	Carrying Capacity	Length of jib	Swivel area	Mounting plate	Weight	Art.No.:	Price DM	Price Euro
WSK-85-2000	125 kg	2000 mm	180°	590x150 mm			1.080,00 DM	552,20 €
WSK-85-3000	80 kg	3000 mm	180°	590x150 mm			1.180,00 DM	603,32 €
WSK-85-4000	60 kg	4000 mm	180°	590x150 mm			1.360,00 DM	695,36 €
WSK-125-2000	250 kg	2000 mm	180°	590x150 mm			1.220,00 DM	623,78 €
WSK-125-3000	125 kg	3000 mm	180°	590x150 mm			1.420,00 DM	726,03 €
WSK-125-4000	80 kg	4000 mm	180°	590x150 mm			1.560,00 DM	797,62 €
WSK-125-5000	60 kg	5000 mm	180°	590x150 mm			1.980,00 DM	1.012,36 €

Dimensions:	L	L 1	H	H 1	H 2	H 3	B	B 1	FH	FV
WSK-85-2000	2000 mm	150 mm	590 mm	508 mm	40 mm	50 mm	150 mm	110 mm	5,0 kN	3,0 kN
WSK-85-3000	3000 mm	150 mm	590 mm	508 mm	40 mm	50 mm	150 mm	110 mm	5,0 kN	2,5 kN
WSK-85-4000	4000 mm	150 mm	590 mm	508 mm	40 mm	50 mm	150 mm	110 mm	5,0 kN	2,0 kN
WSK-125-2000	2000 mm	150 mm	590 mm	508 mm	40 mm	30 mm	150 mm	110 mm	8,5 kN	5,0 kN
WSK-125-3000	3000 mm	150 mm	590 mm	508 mm	40 mm	30 mm	150 mm	110 mm	8,5 kN	3,0 kN
WSK-125-4000	4000 mm	150 mm	590 mm	508 mm	40 mm	30 mm	150 mm	110 mm	8,5 kN	2,5 kN
WSK-125-5000	5000 mm	150 mm	590 mm	508 mm	40 mm	30 mm	150 mm	110 mm	8,5 kN	2,0 kN

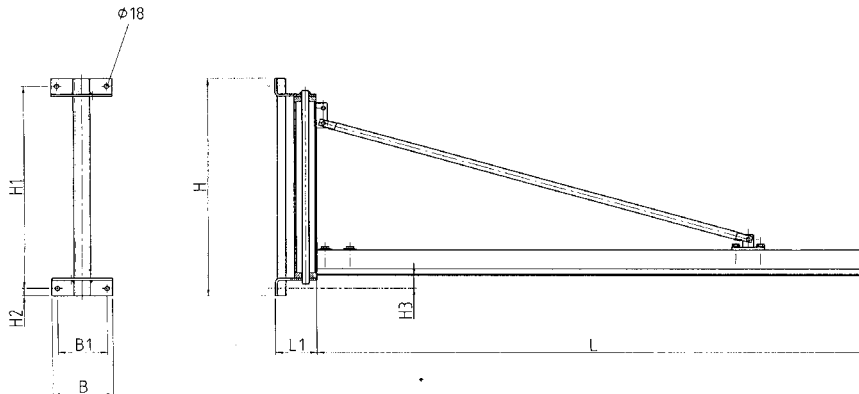

Accessories:	Designation:	Art.No.:	Price DM	Price Euro
Mounting set I	4 x Heavy duty dowels M 16x120		48,00 DM	24,54 €
Mounting set II	4 x Heav duty dowels M16x190		56,00 DM	28,63 €

Carrying capacities The own weight of the VacuPowerlift is not considered at the indication of the carrying capacity of the crane this means that the stated carrying capacities refer to the max. possible transport weight.

Model: The rail systems are aluminium systems which are anodized.  
All steel parts are varnished (RAL) or galvanized.

Scope of delivery: in the scope are included: - 1 Trolley for suspension of the VacuPowerlift  
- 1 up to 4 Vehicles for the hose (depending on length of jib) for blower hose  
- End stop with bump rubber

# Column slewing jibs

Profile System 85 mm and 125 mm

Designation:	Carrying Capacity	Length of jib	Swivel area	Mounting plate	Weight	Art.No.:	Price DM	Price Euro
SSK-85-2000	125 kg	2000 mm	270°	400x400			1.980,00 DM	1.012,36 €
SSK-85-3000	80 kg	3000 mm	270°	400x400			2.080,00 DM	1.063,49 €
SSK-85-4000	60 kg	4000 mm	270°	400x400			2.260,00 DM	1.155,52 €
SSK-125-2000	250 kg	2000 mm	270°	500x500			2.170,00 DM	1.109,50 €
SSK-125-3000	125 kg	3000 mm	270°	500x500			2.370,00 DM	1.211,76 €
SSK-125-4000	80 kg	4000 mm	270°	500x500			2.510,00 DM	1.283,34 €
SSK-125-5000	60 kg	5000 mm	270°	500x500			2.930,00 DM	1.498,09 €

Dimensions:	L	L1	B	B1	H	H1	H2	H3	FS	MS
SSK-85-2000	2000 mm	150 mm	400 mm	125 mm	3860 mm	20 mm	590 mm	3230 mm	5,0 kN	5,0 kNm
SSK-85-3000	3000 mm	150 mm	400 mm	125 mm	3860 mm	20 mm	590 mm	3230 mm	4,5 kN	5,5 kNm
SSK-85-4000	4000 mm	150 mm	400 mm	125 mm	3860 mm	20 mm	590 mm	3250 mm	4,0 kN	5,0 kNm
SSK-125-2000	2000 mm	150 mm	400 mm	125 mm	3860 mm	20 mm	590 mm	3230 mm	7,0 kN	9,0 kNm
SSK-125-3000	3000 mm	150 mm	400 mm	125 mm	3860 mm	20 mm	590 mm	3230 mm	5,5 kN	8,0 kNm
SSK-125-4000	4000 mm	150 mm	400 mm	125 mm	3860 mm	20 mm	590 mm	3230 mm	5,0 kN	8,0 kNm
SSK-125-5000	5000 mm	150 mm	400 mm	125 mm	3860 mm	20 mm	590 mm	3230 mm	4,5 kN	7,0 kNm

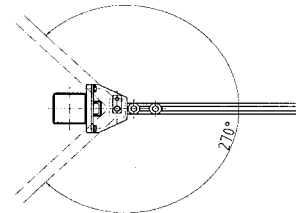
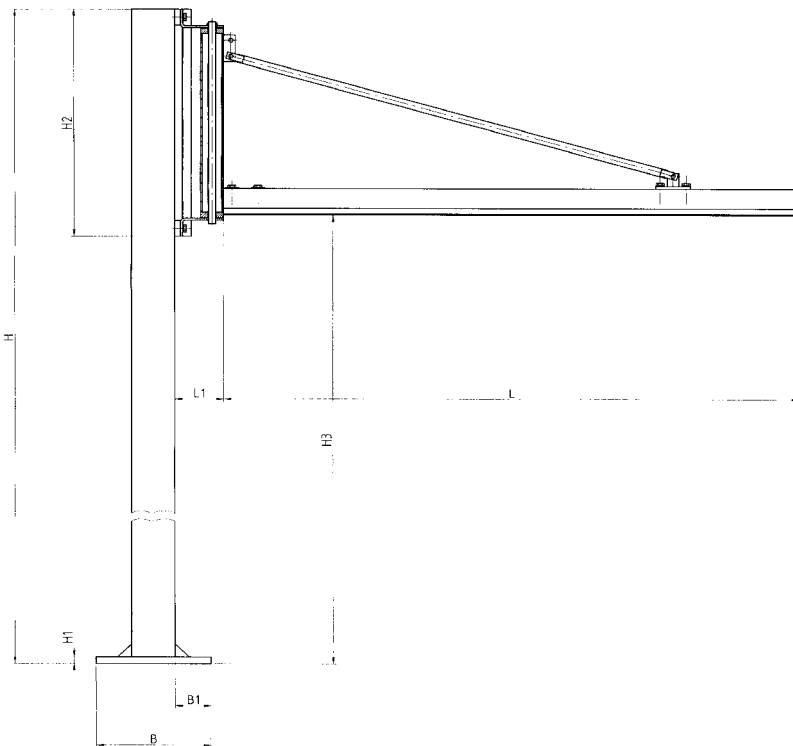

\* The column slewing jibs can alternatively be installed on steel base plates (see next page)

The own weight of the VacuPowerlift ist not considered at the indication of the carrying capacity of the crane. This means that the stated carrying capacities refer to the max. possible transport weight.

The rail systems are aluminium systems which are anodized. All steel parts are varnished or galvanized.

- in the scope are included:
- 1 trolley for suspension of the VacuPowerlift
  - 1 to 4 vehicles for the hose of the blower
  - End stop with bump rubber

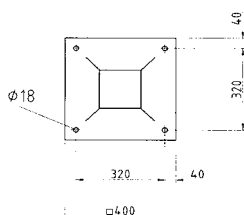

Mounting Plate

Zubehörteile:	Designation:	Art.No.:	Price DM	Price Euro
Befestigungsset I	4xHeavy duty dowels M 16x190		56,00 DM	28,63 €
Befestigungsset II	4xAnchor bolts. M16x190 + Cartridge		96,00 DM	49,08 €

Base plate for Column Slewing Jibs	
Designation:	GP-SSK, for maximal load of 125 kg
Installation:	direct on floor without additional mounting
Mobility:	Moveable through lift truck or stacker
Dimensions: LxWxH	1500 x 1300 x 140
LW from floor	ca. 90 mm
Scope of delivery:	4 x screws M 16x55, discs
Connection possibilities:	existing bore configuration for blower and silencer box
Weight:	ca. 700 kgs
Art.-No.:	5.24.4.0001
old Art.-Nr:	269 412
Price Euro	1.406,00 €

Accessories and spare parts for slewing jibs				
		Art.-No.:	old Art.-Nr:	Price Euro
Transport vehicle 60 kgs	steel model with grooved ball bearing	4.24.1.0001	269 404	126,80 €
Transport vehicle 125 kg	steel model with grooved ball bearing	4.24.1.0002	269 405	166,20 €
Hose vehicle	plastic model with rolls	4.24.1.0003	269 406	25,00 €
Hose belt	for mounting of the hose on the trolley	5.26.4.0002	269 407	2,50 €
Bump rubber	for end stop of the rail	6.29.3.0008	269 408	4,50 €
Karabiner	max. load 1.500 kgs	6.29.1.0001	269 409	7,40 €
Foundation templet	for Column Slewing Jibs 60 kgs	4.24.9.0003	269 410	61,90 €
Foundation templet	for Column Slewing Jibs 125 kgs	4.24.9.0002	269 411	71,00 €

## We bring movement into your transport problems

New ways, innovative ideas - solutions from FEZER. Who gives impulses, who achieves progress and wants to attain highest perfection, calls existing things into question and develops own ideas. The Albert Fezer Maschinenfabrik GmbH offers you with the following products innovative and custom made vacuum transport and automation techniques.

Ask for further information - Your FEZER team is looking forward to answering your questions.

### Vacuum Components

- Vacuum suction cups
- Vacuum suction plates
- Mounting elements
- Vacuum generators
- Control valves
- Measuring devices
- Vacuum filters
- Vacuum accessories



### VacuBoy

Innovative vacuum load lifting device in a modular construction system for loads up to 2.000 kgs. Universally applicable for different materials like sheet metals, glas, aluminium, plastic and many others. Suitable for horizontal and vertical transport with a stepless swivel unit.



### VacuCoil

Efficient and gentle handling of coils and split strips. Suitable for different diameters and weights. With transparent suction plate or suction plate with viewing window. Stepless swivel unit from 0 to 90 degrees.



### VacuPoro

Vacuum load lifting device for the transport of air-permeable and porous materials like particle boards and MDF-plates. A vacuum blower with deceleration flywheel guarantees a high safety standard also in case of a power failure. The unit is available in a horizontal and tiltable design.

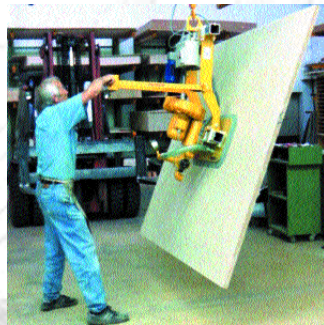

### VacuStand

Ergonomic and general working of dense goods with a smooth surface. Due to the stepless height adjustment, the non-stop turning and the 90 degrees tilting mechanism the workpiece can be hold in any position and worked effortless.



### VacuTrans

Fully automatic vacuum transporting unit for weights up to 2.000 kgs. Complete project engineering for complete solutions including conveyer systems and SPS controls. The units are designed in one and two railway version and guarantee shortest cycle times.

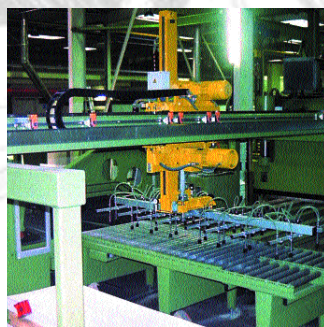

Art.-Nr: 100 022  
3/00-5000-sche

Technical changes reserved



Albert Fezer Maschinenfabrik GmbH  
Hauptstrasse 37 - 39, D-73730 Esslingen  
Tel: + 49 (0) 711 / 3 60 09 - 0  
Fax: + 49 (0) 711 / 3 60 09 - 40  
Mail: fezer@fezer.de  
Web: www.fezer.de